

STORAGE OF CLASS 1, 2, 3, 4 AND PLASTIC COMMODITIES

Table of Contents

| | Page |
|--|------|
| 1.0 SCOPE | 5 |
| 1.1 Changes | 5 |
| 1.2 Superseded Information | 5 |
| 1.3 How to Use This Data Sheet | 5 |
| 2.0 LOSS PREVENTION RECOMMENDATIONS | 8 |
| 2.1 Construction and Location | 8 |
| 2.1.1 General | 8 |
| 2.1.2 Steel Column Protection | 8 |
| 2.1.3 Heat and Smoke Venting and Draft Curtains | 8 |
| 2.2 Occupancy | 8 |
| 2.2.1 General | 8 |
| 2.2.2 Commodity Hazard | 8 |
| 2.2.3 Storage Arrangements | 9 |
| 2.2.4 Open-Top Containers Maintained in Storage Racks | 22 |
| 2.2.5 Pallets | 25 |
| 2.2.6 Clearance Between Top of Storage and Ceiling-Level Sprinkler Deflector | 25 |
| 2.3 Protection | 25 |
| 2.3.1 General | 25 |
| 2.3.2 Sprinkler System Types | 25 |
| 2.3.3 Ceiling-Level Storage Sprinklers | 26 |
| 2.3.4 In-Rack Sprinklers (IRAS) | 41 |
| 2.3.5 Hose Demands, Hose Connections, and System Duration | 62 |
| 2.3.6 Special Applications | 63 |
| 3.0 SUPPORT FOR RECOMMENDATIONS | 80 |
| 3.1 General | 80 |
| 3.2 Loss History | 80 |
| 3.3 Illustrative Losses | 81 |
| 3.3.1 Roll Cloth in Racks Obstruct Flue Spaces, Resulting in Extensive Fire and Water Damage .. | 81 |
| 3.3.2 Many Loss Prevention Principles Compromised in Warehouse Fire | 81 |
| 3.3.3 Inadequate Sprinkler Protection Unable to Control Fire Involving Aisle Storage and Racks with Solid Shelves | 82 |
| 3.3.4 Fire in High Rack-Storage Controlled by In-Rack Sprinklers | 82 |
| 3.3.5 Lack of In-Rack Sprinklers for Racks With Solid Shelves Results in Extensive Fire Damage | 82 |
| 3.3.6 Open-Top Containers in Racks Interfere with Sprinkler Water Penetration Resulting in Uncontrolled Fire | 82 |
| 3.3.7 Poor Housekeeping Leads to Excessive Fire Spread | 82 |
| 3.3.8 Strong Water Supply Overcomes Plugged Sprinklers | 83 |
| 4.0 REFERENCES | 83 |
| 4.1 FM | 83 |
| APPENDIX A GLOSSARY OF TERMS | 83 |
| APPENDIX B DOCUMENT REVISION HISTORY | 94 |



List of Figures

| | |
|---|----|
| Fig. 1. Flowchart for determining the protection options for solid-piled, palletized, shelf, and bin-box storage arrangements | 6 |
| Fig. 2. Flowchart for determining the protection options available for rack storage arrangements | 7 |
| Fig. 2a. Acceptable transverse flue space arrangement for single-row racks, Option 1 | 11 |
| Fig. 2b. Acceptable transverse flue space arrangement for single-row racks, Option 2 | 12 |
| Fig. 2c. Acceptable transverse flue space arrangement for single-row racks, Option 3 | 13 |
| Fig. 2d. Acceptable flue space arrangement for double-row racks, Option 1 | 15 |
| Fig. 2e. Acceptable flue space arrangement for double-row racks, Option 2 | 16 |
| Fig. 2f. Acceptable flue space arrangement for double-row racks, Option 3 | 17 |
| Fig. 2g. Acceptable flue space arrangement for double-row racks, Option 4 | 18 |
| Fig. 2h. Acceptable transverse flue space arrangement for open-frame multiple-row racks, Option 1 | 20 |
| Fig. 2i. Acceptable transverse flue space arrangement for open-frame multiple-row racks, Option 2 | 21 |
| Fig. 2j. Horizontal in-rack sprinkler arrangement for indicated conditions when single-row racks deeper than 3 ft (0.9 m) | 24 |
| Fig. 2k. Horizontal in-rack sprinkler arrangement for open-top containers maintained in double-row racks having solid shelves greater than 64 ft ² (6.0 m ²) in area. | 24 |
| Fig. 2l. Extension of hydraulic design | 28 |
| Fig. 3. Flowchart for evaluating the need for in-rack sprinklers | 42 |
| Fig. 4. Example of protecting in-rack sprinklers and sprinkler piping in a double-row rack | 44 |
| Fig. 5. Recommended horizontal in-rack sprinkler arrangements for single-row racks up to 3 ft (0.9 m) deep | 46 |
| Fig. 5a. Recommended horizontal in-rack sprinkler arrangements for single-row racks over 3 ft (0.9 m) deep | 47 |
| Fig. 6. Recommended horizontal in-rack sprinkler arrangements for double-row racks up to 9 ft (2.7 m) deep | 48 |
| Fig. 6a. Recommended horizontal in-rack sprinkler arrangements for double-row racks over 9 ft (2.7 m) deep | 49 |
| Fig. 7. Recommended horizontal in-rack sprinkler arrangements for multiple-row racks | 50 |
| Fig. 8. Plan view of IRAS(EO) horizontal in-rack sprinkler arrangement for single-row racks | 51 |
| Fig. 9. Plan view of IRAS(EO) horizontal in-rack sprinkler arrangement for double-row racks up to 9 ft (2.7 m) deep | 51 |
| Fig. 9a. Plan view of IRAS(EO) horizontal in-rack sprinkler arrangement for double-row racks over 9 ft (2.7 m) deep | 51 |
| Fig. 10. Plan view of IRAS(EO) horizontal in-rack sprinkler arrangement for multiple-row racks | 52 |
| Fig. 11. Plan view of IRAS(E) horizontal in-rack sprinkler arrangement for single-row racks | 52 |
| Fig. 11a. Plan view of IRAS(E) horizontal in-rack sprinkler arrangement for single-row racks over 3 ft (0.9 m) wide | 52 |
| Fig. 12. Plan view of IRAS(E) horizontal in-rack sprinkler arrangement for double-row racks having a maximum depth of 9 ft (2.7 m) | 53 |
| Fig. 12a. Plan view of IRAS(E) horizontal in-rack sprinkler arrangement for double-row racks over 9 ft (2.7 m) deep | 53 |
| Fig. 13. Plan view of IRAS(E) horizontal in-rack sprinkler arrangement for double-row racks (face and flue) | 54 |
| Fig. 14. Plan view of IRAS(E) horizontal in-rack sprinkler arrangement for multiple-row racks | 54 |
| Fig. 15. Recommended vertical in-rack sprinkler increments | 56 |
| Fig. 16. Fire Protection Scheme 8-9A within single-row racks | 60 |
| Fig. 17. Fire Protection Scheme 8-9A within double-row racks | 61 |
| Fig. 18. Fire Protection Scheme 8-9A within multiple-row racks | 62 |
| Fig. 19a. Plan view of alternative in-rack sprinkler arrangement for single-row racks up to 3 ft (0.9 m) deep .. | 69 |
| Fig. 19b. Plan view of alternative in-rack sprinkler arrangement for single-row racks up to 6 ft (1.8 m) deep .. | 69 |
| Fig. 19c. Plan view of alternative in-rack sprinkler arrangement for single-row racks up to 6 ft (1.8 m) deep located against wall | 69 |
| Fig. 20a. Plan view of alternative in-rack sprinkler arrangement for double-row racks up to 9 ft (2.7 m) deep | 70 |
| Fig. 20b. Plan view of alternative in-rack sprinkler arrangement for double-row racks up to 12 ft (3.7 m) deep | 70 |

Fig. 21. Plan view of alternative in-rack sprinkler arrangement for multiple-row racks 70

Fig. 22. Determining ceiling height in applicable protection table 72

Fig. 23. Protection of uncartoned plastics in open-frame, single-row racks over 3 ft (0.9 m) and up to 6 ft (1.8 m) deep 74

Fig. 24. Protection of uncartoned plastics in open-frame, double-row racks up to 9 ft (2.7 m) deep 75

Fig. 25. Vertical distance between ceiling and centerline of sprinkler’s thermal element in the presence of mineral wool or glass fiber batt insulation. 79

Fig. A-1. Typical double-row (back-to-back) rack arrangement 85

Fig. A-2. Typical wooden pallets 87

Fig. A-3. Open-frame double-row racks 88

Fig. A-4. Double-row racks with solid shelves 89

Fig. A-5. Double-row racks with slatted shelves 89

Fig. A-6. Automatic storage rack 90

Fig. A-7. Multiple-row rack 90

Fig. A-8. Flow-through pallet rack 91

Fig. A-9. Drive-in rack, two or more pallets deep 91

Fig. A-10. Flow-through and portable racks 92

Fig. A-11. Cantilever rack 92

Fig. A-12. Example arrangement of an inspector’s test connection for a dry sprinkler system design using 2 sprinklers on the most remote branchline 93

Fig. A-13. Example arrangement of an inspector’s test connection for a dry sprinkler system design using 2 sprinklers on the most remote 2 branchlines (4 sprinklers total) 93

List of Tables

Table 1. Spacing of Ceiling-Level Storage Sprinklers Under Unobstructed Ceiling Construction 27

Table 1a. Determining Number of Sprinklers per Branchline for Ceiling Sprinkler System Hydraulic Design . 31

Table 2. Ceiling-Level Protection Guidelines for Class 1, 2, and 3 Commodities in a Solid-Piled, Palletized, Shelf, or Bin-Box Storage Arrangement 32

Table 3. Ceiling-Level Protection Guidelines for Class 4 and Cartoned Unexpanded Plastic Commodities in a Solid-Piled, Palletized, Shelf, or Bin-Box Storage Arrangement 33

Table 4. Ceiling-Level Protection Guidelines for Cartoned Expanded Plastic Commodities in a Solid-Piled, Palletized, Shelf, or Bin-Box Storage Arrangement 34

Table 5. Ceiling-Level Protection Guidelines for Uncartoned Unexpanded Plastic Commodities in a Solid-Piled, Palletized, Shelf, or Bin-Box Storage Arrangement 35

Table 6. Ceiling-Level Protection Guidelines for Uncartoned Expanded Plastic Commodities in a Solid-Piled, Palletized, Shelf or Bin-Box Storage Arrangement 35

Table 7. Ceiling-Level Protection Guidelines for Class 1, 2 and 3 Commodities in Open-Frame Rack Storage Arrangements 36

Table 8. Ceiling-Level Protection Guidelines for Class 4 and Cartoned Unexpanded Plastic Commodities in Open-Frame Rack Storage Arrangements 37

Table 9. Ceiling-Level Protection Guidelines for Cartoned Expanded Plastic Commodities in Open-Frame Rack Storage Arrangements 38

Table 10. Ceiling-Level Protection Guidelines for Uncartoned Unexpanded Plastic Commodities in Open-Frame Rack Storage Arrangements 38

Table 11. Ceiling-Level Protection Guidelines for Uncartoned Expanded Plastic Commodities in Open-Frame Rack Storage Arrangements 39

Table 12. Hydraulic Design for In-Rack Sprinkler Systems 57

Table 13. Determining Applicable Protection Table and Ceiling Height for Ceiling Sprinkler Designs when Ceiling-Level Sprinkler Systems are Supplemented with In-Rack Sprinklers 58

Table 14. Hose Demand and Water Supply Duration Design Guidelines 63

Table 14a. Ceiling-Level Sprinkler System Designs for Class 1 and 2 Commodities Protected by Dry-Pipe and Similar Sprinkler Systems 64

Table 14b. Ceiling-Level Sprinkler System Designs for Class 3 Commodities Protected by Dry-Pipe and Similar Sprinkler Systems 65

Table 15. Number of Sprinklers in the In-Rack Sprinkler System Design 71

Table 16. Minimum Flow in the In-Rack Design 71

Table 17. Number of Face In-Rack Sprinklers in the Retrofit In-Rack Design 76

8-9 Storage of Class 1, 2, 3, 4 and Plastic Commodities

| | |
|---|----|
| Table 17a. Minimum Number of K25.2EC (K360EC) Pendent In-Rack Sprinklers Included in the In-Rack Sprinkler Design | 78 |
| Table 17b. Quick-Response, 160°F (70°C) Nominally Rated, Standard-Coverage Pendent Storage Sprinkler Ceiling-Only Designs for Ceiling Heights Over 40 ft (12.0 m) | 80 |
| Table 18. Relationship Between the Number of Sprinklers that Operate During a Storage Fire and Fire Control | 81 |

1.0 SCOPE

This property loss prevention data sheet provides fire protection recommendations for the storage of Class 1, 2, 3, 4, and plastic commodities maintained in rack, solid-piled, palletized, shelf, or bin-box storage arrangements. Apply this data sheet when (1) Class 1, 2 or 3 commodities are stored higher than 10 ft (3.0 m), or (2) Class 4 or plastic commodities are stored higher than 6 ft (1.8 m). Use the applicable occupancy-specific data sheet (see Appendix A for definition) when storage consists of commodity hazards other than Class 1, 2, 3, 4 or plastics.

See Data Sheet 8-1, *Commodity Classification*, for guidelines on how to classify individual commodities; see Section 2.2.2 for information on how to determine an overall commodity rating for a given storage area.

Refer to FM Data Sheet 2-0, *Installation Guidelines for Automatic Sprinklers*, for installation guidelines for the sprinklers listed in this data sheet, as well as their compatibility with the facility's construction features.

The recommendations in Data Sheet 8-9 are intended for the design of new automatic sprinkler systems, or existing systems that are to be modified. To evaluate existing automatic sprinkler systems, or to determine whether new protection options based on recently FM Approved products and/or fire testing are a viable option to help lower their risk of loss, clients of FM can contact their local FM servicing office.

The fire protection recommendations in this data sheet are based on the results of full-scale fire testing, loss experience, and/or engineering judgment. Not every storage arrangement or protection option has been tested, nor has every potential solution been identified. If FM data sheets exist that address the specific occupancy, refer to those data sheets for further guidance.

Refer to the applicable occupancy-specific data sheet for loss prevention recommendations related to the following subjects, which are not covered in this data sheet:

- Special hazards, such as the storage of flammable gases, flammable liquids, and flammable solids (usually found in 7-series data sheets)
- Commodities such as rubber tires, baled fiber, hanging garments, roll paper, baled waste paper, rolled non-woven fabrics, and carpets (usually found in 8-series data sheets)
- Storage arrangements, such as carousel storage (Data Sheet 8-33) or automatic storage and retrieval systems (Data Sheet 8-34)

Before selecting one of the protection options in this data sheet for either a new building or a building being retrofitted with a new protection system, consider possible future changes in storage arrangements, available water supplies, and/or commodity hazards. Also consider the susceptibility of the occupancy to nonthermal damage. If ceiling-only protection options are available, consider protecting to the highest commodity hazard that the ceiling height and the available water supply will allow in order to provide as much flexibility as possible for future changes in occupancy or water supply.

Note that the metric (SI) equivalent values in this data sheet are not based on strict mathematical conversion, but on design-desired values.

1.1 Changes

October 2024. Interim revision. Minor editorial changes were made.

1.2 Superseded Information

This edition of Data Sheet 8-9 did not incorporate or supersede any new engineering bulletins subsequent to the previously released edition of Data Sheet 8-9.

1.3 How to Use This Data Sheet

As with any FM data sheet, a complete and comprehensive understanding of the information in this document can only be achieved by a thorough review of its content. To assist with the proper use of this data sheet, however, two flowcharts have been created. The first flowchart (Figure 1) represents the process for determining the proper design of an automatic sprinkler system that is intended to protect solid-piled, palletized, shelf, or bin-box storage arrangements. The second flowchart (Figure 2) represents the process for determining the proper design of an automatic sprinkler system that is intended to protect rack storage.

Use these two flowcharts in combination with the text of this data sheet to determine all possible protection options.

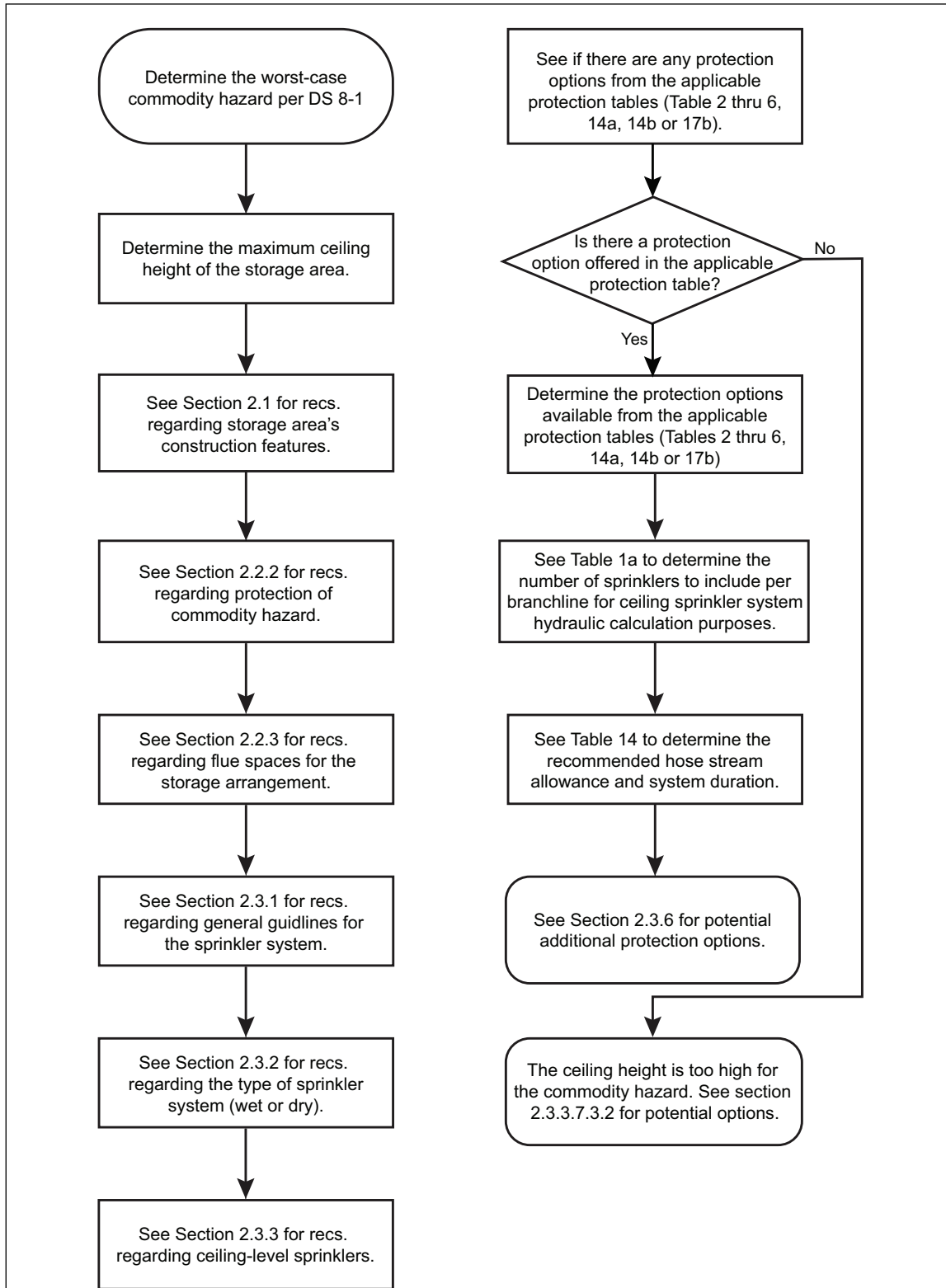

Fig. 1. Flowchart for determining the protection options for solid-piled, palletized, shelf, and bin-box storage arrangements

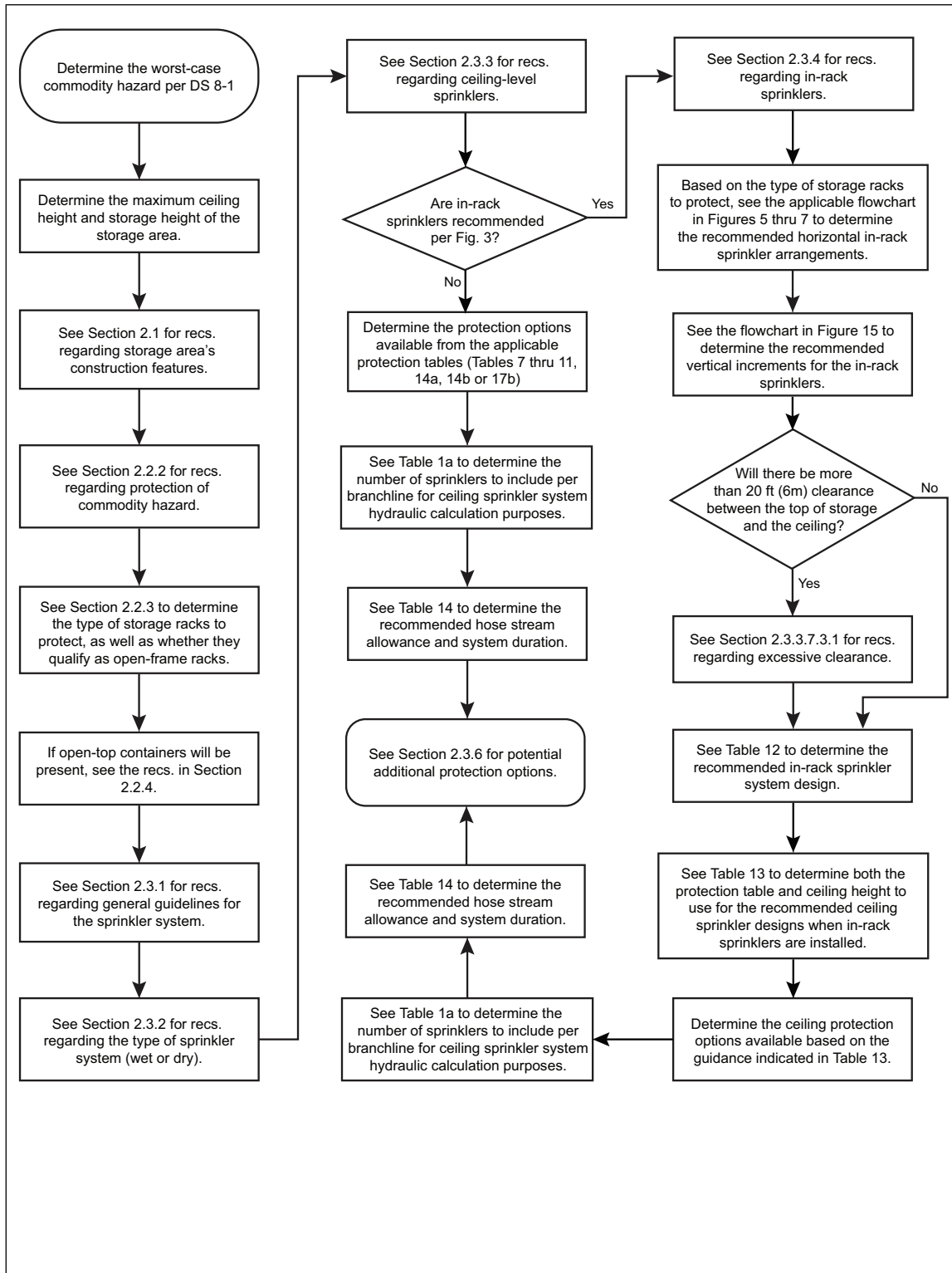

Fig. 2. Flowchart for determining the protection options available for rack storage arrangements

2.0 LOSS PREVENTION RECOMMENDATIONS

2.1 Construction and Location

2.1.1 General

2.1.1.1 Construct storage facilities in accordance with the relevant FM property loss prevention data sheets. See the 1-series data sheets for guidelines relevant to the construction features of most storage facilities.

2.1.1.2 Adhere to the recommendations in the relevant data sheet to ensure the construction features of the facility are compatible with the Storage sprinkler being used.

2.1.1.3 Properly anchor all rack storage structures to prevent them from falling over and, in turn, causing nearby racks to fall over (i.e., creating a “domino” effect). Take into consideration the effects of rack loads, the additional load created by the collection or absorption of fire protection water by the stored commodity, the weight of water-filled, in-rack sprinkler piping (if provided), and any seismic conditions (see Data Sheet 1-2, *Earthquakes*).

2.1.1.4 Design rack-supported structures taking into consideration the effects of weather (wind, snow, rain, hail, etc.), rack loads, seismic conditions (see Data Sheet 1-2, *Earthquakes*), and the additional load created by the collection or absorption of fire protection water by the stored commodity, the weight of water-filled sprinkler piping (from ceiling or in-rack sprinklers), and any other loads to which the rack or structure may be exposed. Account for additional weight created by the absorption of sprinkler water by corrugated containers. Assume a value of 0.012 lb (5.44 g) per 1 ft³ (0.028 m³) and apply this value to the overall volume of the pallet load. If open-top containers are present, assume roughly one-third of the containers stored vertically will be filled with water, but the other two-thirds of containers will be completely consumed during a fire event.

2.1.2 Steel Column Protection

Adhering to the design guidelines in this data sheet eliminates the need for both building column and overhead steel protection.

2.1.3 Heat and Smoke Venting and Draft Curtains

2.1.3.1 Heat and Smoke Venting

See Data Sheet 2-0, *Installation Guidelines for Automatic Sprinklers*, for recommendations related to the use of heat and smoke venting in the presence of Storage sprinklers.

2.1.3.2 Draft Curtains

See Data Sheet 2-0, *Installation Guidelines for Automatic Sprinklers*, for recommendations related to the use of draft curtains in the presence of Storage sprinklers.

2.2 Occupancy

2.2.1 General

2.2.1.1 Storage arrangements covered in this data sheet include solid-piled, palletized, shelf, bin-box, or single-row, double-row, or multiple-row racks. Within this data sheet, the design guidelines for solid-piled, palletized, shelf, or bin-box storage arrangements are consolidated into the same protection table for a given commodity hazard. Similarly, the design guidelines for single-row, double-row, and multiple-row storage racks are consolidated into the same protection table for a given commodity hazard.

2.2.1.2 For storage that will be maintained directly on the floor, refer to Data Sheet 1-24, *Protection Against Liquid Damage*, to minimize the exposure from sprinkler water discharge or other potential liquid releases.

2.2.2 Commodity Hazard

2.2.2.1 Use Data Sheet 8-1, *Commodity Classification*, to determine the types of commodity hazards located within a given storage area.

2.2.2.2 Base the protection for the storage area on the most severe commodity hazard present anywhere within that storage area. The commodity hazards for this data sheet are generally ranked from lowest hazard (Class 1) to highest hazard (uncartoned expanded plastic) as follows:

- Class 1
- Class 2
- Class 3
- Class 4
- Cartoned Unexpanded Plastic
- Cartoned Expanded Plastic
- Uncartoned Unexpanded Plastic
- Uncartoned Expanded Plastic

2.2.2.3 See Section 2.3.4.9 regarding Scheme 8-9A if the most severe commodity hazard exists in relatively small amounts throughout the storage area and protecting it creates a challenge.

2.2.3 Storage Arrangements

2.2.3.1 Solid-Piled, Palletized, Shelf, and Bin-Box Storage Arrangements

2.2.3.1.1 Solid-Piled and Palletized Storage Arrangements

Maintain vertically aligned flue spaces throughout the entire height of storage in solid-piled and palletized storage arrangements. There are no minimum flue space guidelines for solid-piled and palletized storage arrangements.

2.2.3.1.2 Shelf Storage

Arrangements can be treated as shelf storage when:

- A. The depth of the storage shelf does not exceed 30 in. (750 mm), or
- B. The depth of the storage shelf does not exceed 5 ft (1.5 m) and the height between tiers does not exceed 2 ft (0.6 m), or
- C. The depth of the storage shelf does not exceed 5 ft (1.5 m) and a solid vertical barrier, consisting of either minimum 22-gauge (0.7 mm) sheet metal or minimum 3/8 in. (10 mm) plywood, has been installed down the center of the shelf parallel to the loading aisle.

2.2.3.1.3 Bin-Box Storage

Arrangements can be treated as bin-box storage when:

- A. The depth of the solid storage shelf does not exceed 10 ft (3.0 m), and
- B. The height between tiers does not exceed 5 ft (1.5 m), and
- C. The horizontal distance between solid vertical barriers, consisting of either minimum 22-gauge (0.7 mm) sheet metal or minimum 3/8 in. (10 mm) plywood, installed perpendicular to the loading aisle does not exceed 4 ft (1.2 m).

2.2.3.2 Fixed-In-Place Rack Storage Arrangements

2.2.3.2.1 General

2.2.3.2.1.1 Classify storage racks as "single-row" when:

- A. The depth of the storage rack does not exceed 6 ft (1.8 m), and
- B. A minimum 4 ft (1.2 m) wide aisle separates the storage rack from adjacent storage racks.

2.2.3.2.1.2 Classify storage racks as "double-row" when:

- A. The depth of the storage rack exceeds 6 ft (1.8 m), but does not exceed 12 ft (3.7 m), and
- B. A minimum 4 ft (1.2 m) wide aisle separates the storage rack from adjacent storage racks.

2.2.3.2.1.3 Classify storage racks as "multiple-row" for storage racks that do not meet the guidelines for single-row in Section 2.2.3.2.1.1 or double-row racks in Section 2.2.3.2.1.2.

2.2.3.2.1.4 Storage racks with grated and/or mesh shelves can be treated as open-frame racks when:

- A. The shelving has uniform openings comprising at least 70 percent of the overall shelf area, and
- B. Adequate flue spaces are provided as outlined in Sections 2.2.3.2.2 through 2.2.3.2.4.

2.2.3.2.1.5 Storage racks with fixed-in-place slatted shelving can be treated as open-frame racks when:

- A. The slats are arranged to have uniform openings comprising at least 70 percent of the overall shelf area, and
- B. Adequate flue spaces are provided as outlined in Sections 2.2.3.2.2 through 2.2.3.2.4.

2.2.3.2.1.6 Storage racks with fixed-in-place solid shelves can be treated as open-frame racks when:

- A. The overall size of the solid shelving does not exceed 20 ft² (1.9 m²), and
- B. Adequate flue spaces are provided as outlined in Sections 2.2.3.2.2 through 2.2.3.2.4.

2.2.3.2.1.7 Arrange rolled or similar types of commodities stored in racks so they cannot bulge into or encroach over transverse flue spaces. If adequate transverse flue spaces are difficult to maintain (e.g., loading of racks becomes haphazard during peak production), provide a physical means to ensure adequate transverse flue spaces are always maintained.

2.2.3.2.1.8 Classify storage racks that do not meet the guidelines of Sections 2.2.3.2.1.4 through 2.2.3.2.1.7 as storage racks with solid shelves. See Section 2.2.3.2.1.9 for determining the size of the solid shelf area.

2.2.3.2.1.9 The dimension of a solid shelf is defined by its available surrounding flue spaces as follows:

- A. Minimum 6 in. (150 mm) wide vertically aligned transverse flue spaces. However, minimum 3 in. (75 mm) net wide transverse flue spaces are permitted at rack uprights, and
- B. Minimum 3 in. (75 mm) net wide vertically aligned longitudinal flue spaces in double-row racks, or
- C. Minimum 6 in. (150 mm) net wide vertically aligned longitudinal flue spaces in multiple-row racks

2.2.3.2.2 Single-Row Racks

2.2.3.2.2.1 See Section 2.2.3.2.1 if the single-row racks are provided with mesh, slatted, or solid shelving, as well as when rolled-type commodities are maintained within the single-row racks.

2.2.3.2.2.2 Transverse flue spaces for single-row racks are considered adequate when:

- A. Racks void of any misaligned transverse flue spaces throughout the entire height of the rack have minimum 3 in. (75 mm) net wide transverse flue spaces a maximum of every 4-1/2 ft (1.4 m), as indicated in Figure 2a, or
- B. Racks void of any misaligned transverse flue spaces throughout the entire height of the rack have minimum 6 in. (150 mm) net wide transverse flue spaces a maximum of every 9 ft (2.7 m), as indicated in Figure 2b, or
- C. Racks having misaligned transverse flue spaces are provided with minimum 6 in. (150 mm) net wide transverse flue spaces, vertically aligned throughout the entire height of storage, a maximum of every 4-1/2 ft (1.4 m), as indicated in Figure 2c.

2.2.3.2.2.3 Single-row racks can be treated as open-frame racks when:

- A. They qualify as open-frame racks per Section 2.2.3.2.1 (if applicable), and
- B. They have adequate flue spaces per Section 2.2.3.2.2.2

Otherwise, treat the single-row racks as racks with solid shelves. Determine the size of the solid shelf per Section 2.2.3.2.1.9.

2.2.3.2.2.4 When single-row racks are protected by in-rack sprinklers, transverse flue spaces are not required for the tier level located directly above the in-rack sprinklers.

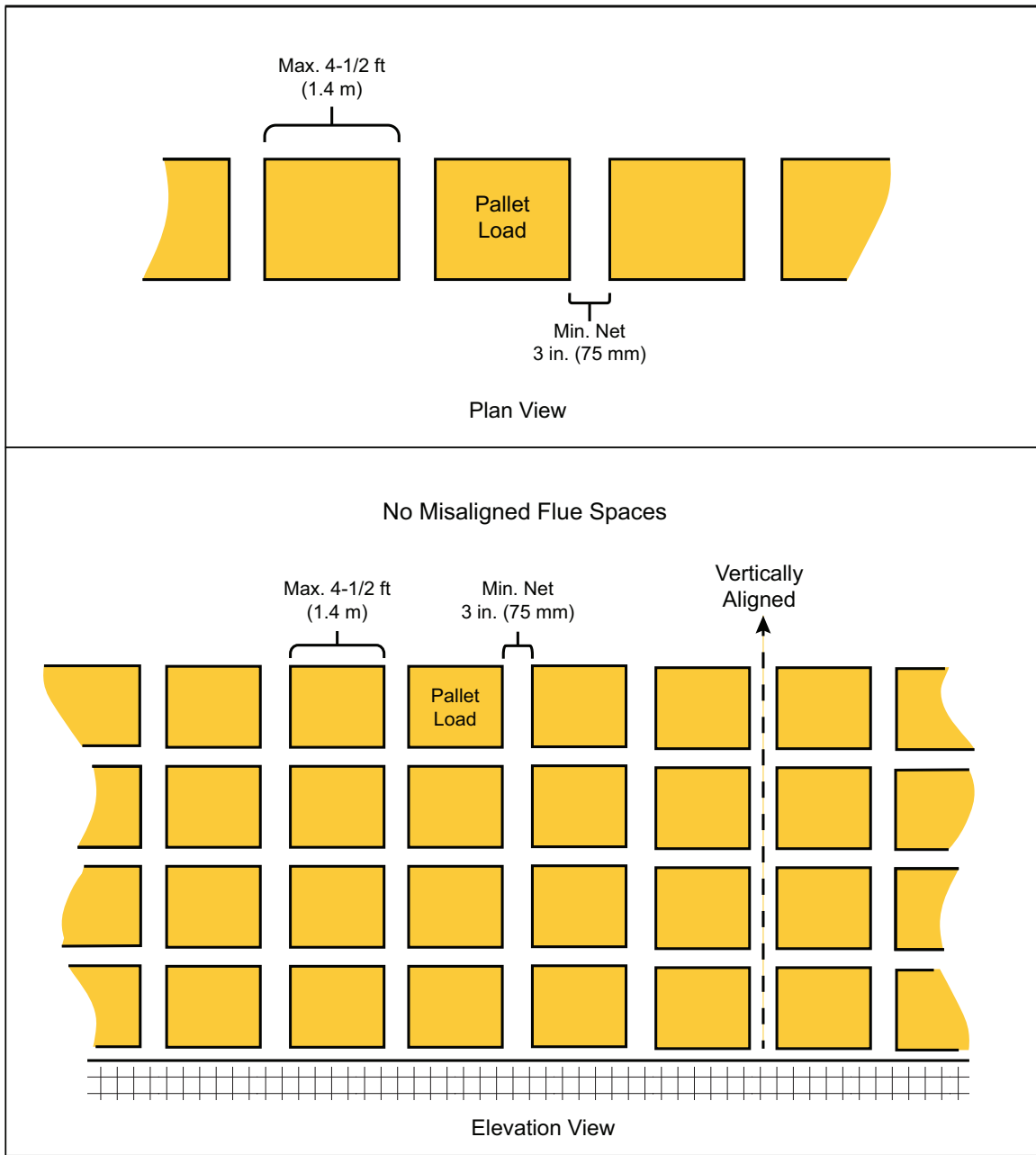

Fig. 2a. Acceptable transverse flue space arrangement for single-row racks, Option 1

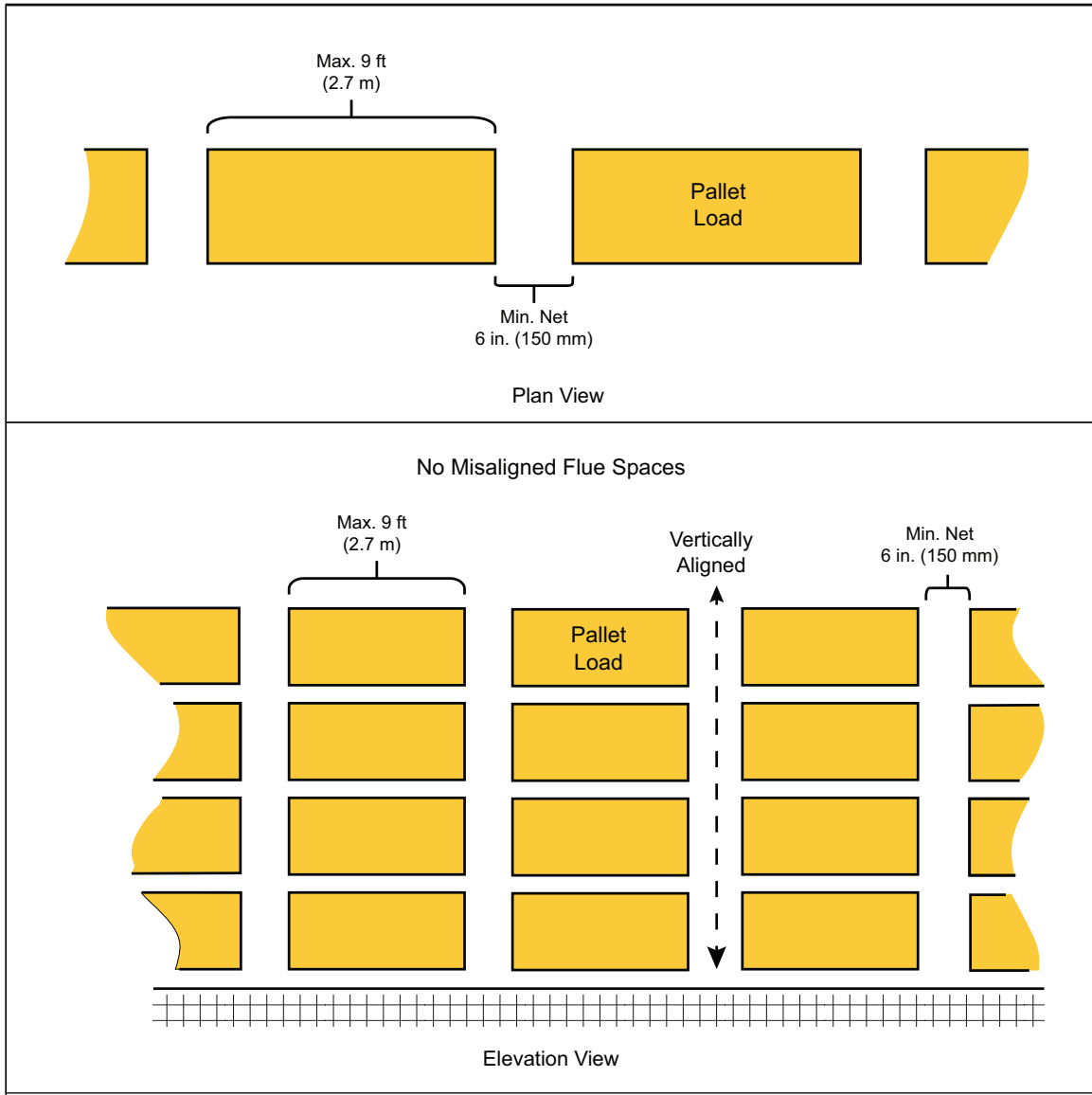

Fig. 2b. Acceptable transverse flue space arrangement for single-row racks, Option 2

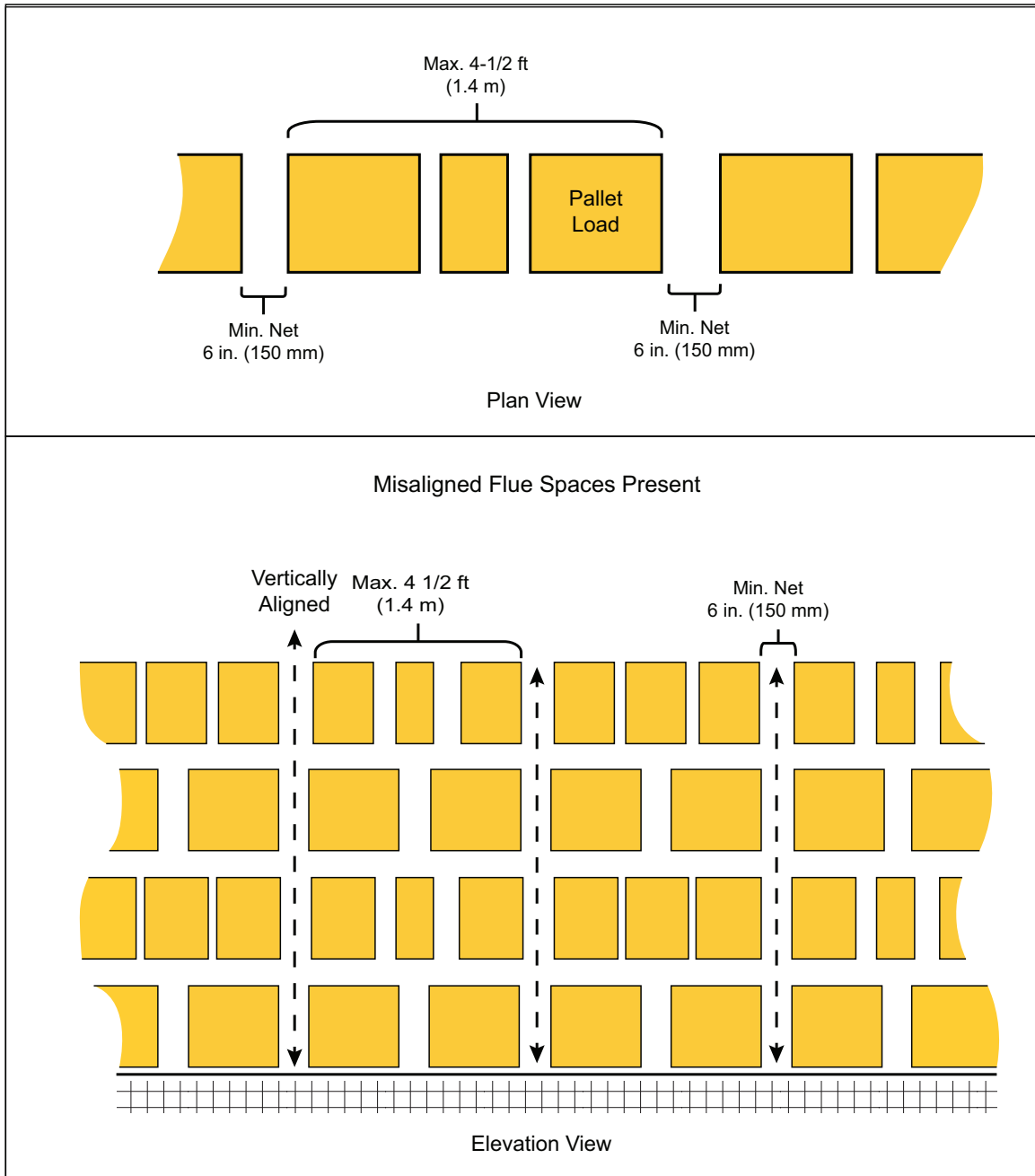

Fig. 2c. Acceptable transverse flue space arrangement for single-row racks, Option 3

2.2.3.2.3 Double-Row Racks

2.2.3.2.3.1 See Section 2.2.3.2.1 if the double-row racks are provided with mesh, slatted, or solid shelving, as well as when rolled-type commodities are maintained within the double-row racks.

2.2.3.2.3.2 Flue spaces for double-row racks are considered adequate when:

A. Racks void of any misaligned flue spaces throughout the entire height of the rack have minimum 3 in. (75 mm) net wide longitudinal flue spaces and minimum 3 in. (75 mm) net wide transverse flue spaces a maximum of every 4-1/2 ft (1.4 m), as indicated in Figure 2d, or

B. Racks void of any misaligned flue spaces throughout the entire height of the rack have minimum 3 in. (75 mm) net wide longitudinal flue spaces and minimum 6 in. (150 mm) net wide transverse flue spaces a maximum of every 9 ft (2.7 m), as indicated in Figure 2e, or

C. Racks void of any misaligned transverse flue spaces throughout the entire height of the rack, but with longitudinal flue spaces less than 3 in. (75 mm) net wide, have minimum 6 in. (150 mm) net wide vertically aligned transverse flue spaces a maximum of every 5 ft (1.5 m), as indicated in Figure 2f, or

D. Racks with misaligned transverse flue spaces have minimum 3 in. (75 mm) net wide longitudinal flue spaces and minimum 6 in. (150 mm) net wide vertically aligned transverse flue spaces a maximum of every 4-1/2 ft (1.4 m), as indicated in Figure 2g.

2.2.3.2.3.3 Double-row racks can be treated as open-frame racks when:

A. They qualify as open-frame racks per Section 2.2.3.2.1 (if applicable), and

B. They have adequate flue spaces per Section 2.2.3.2.3.2

Otherwise, treat the double-row racks as racks with solid shelves. Determine the size of the solid shelf per Section 2.2.3.2.1.9.

2.2.3.2.3.4 When double-row racks are protected by in-rack sprinklers, flue spaces are not required for the tier level located directly above the in-rack sprinklers.

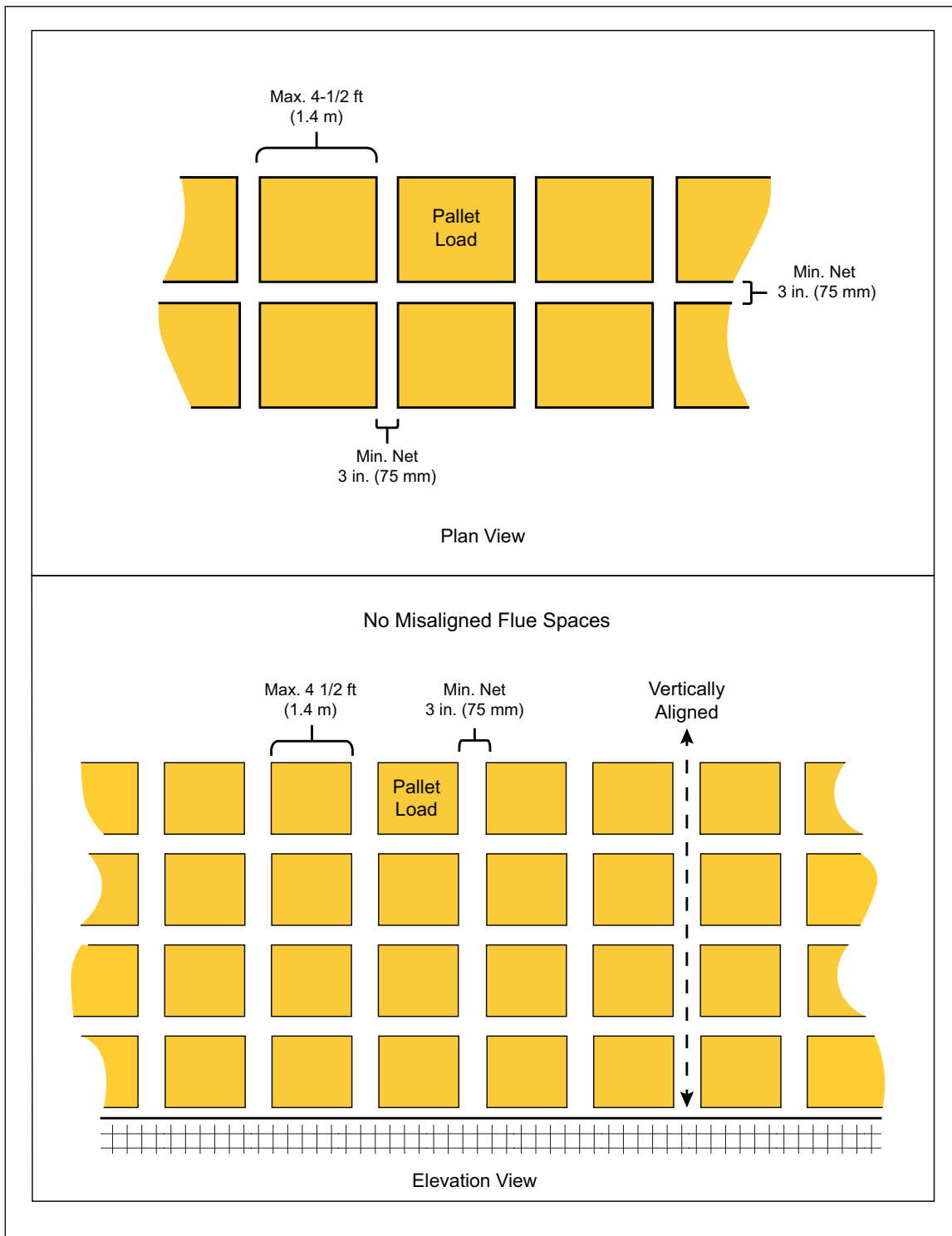

Fig. 2d. Acceptable flue space arrangement for double-row racks, Option 1

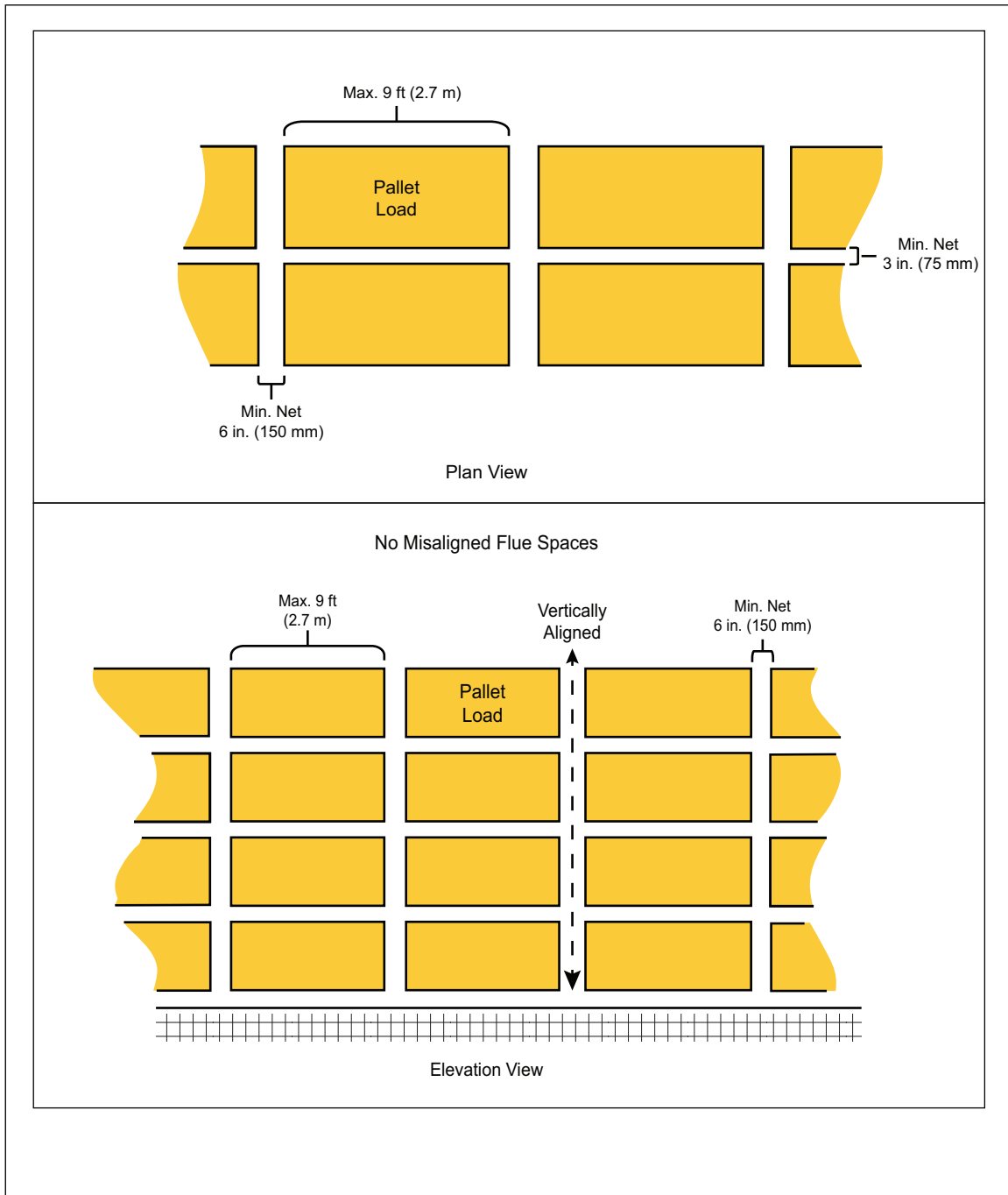

Fig. 2e. Acceptable flue space arrangement for double-row racks, Option 2

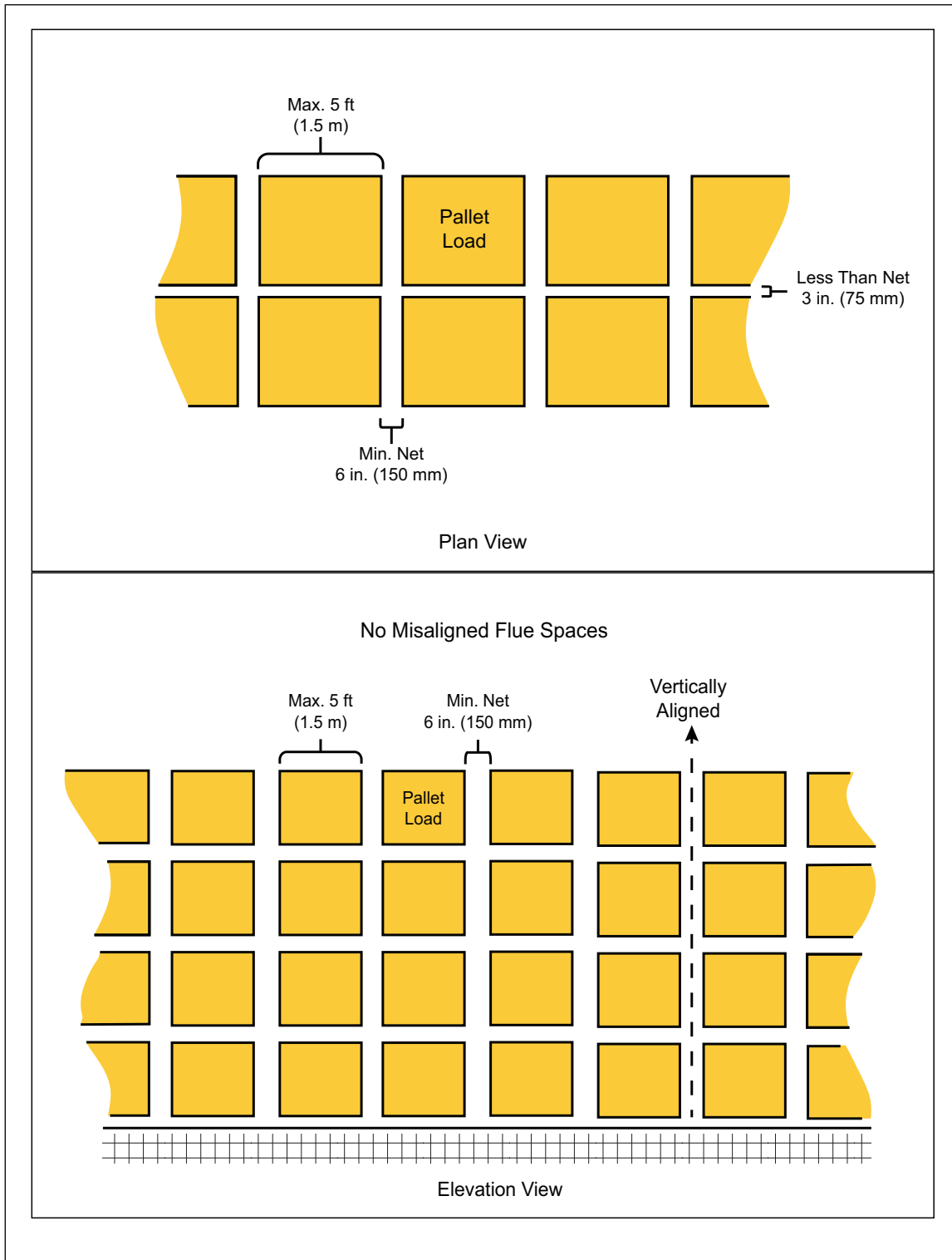

Fig. 2f. Acceptable flue space arrangement for double-row racks, Option 3

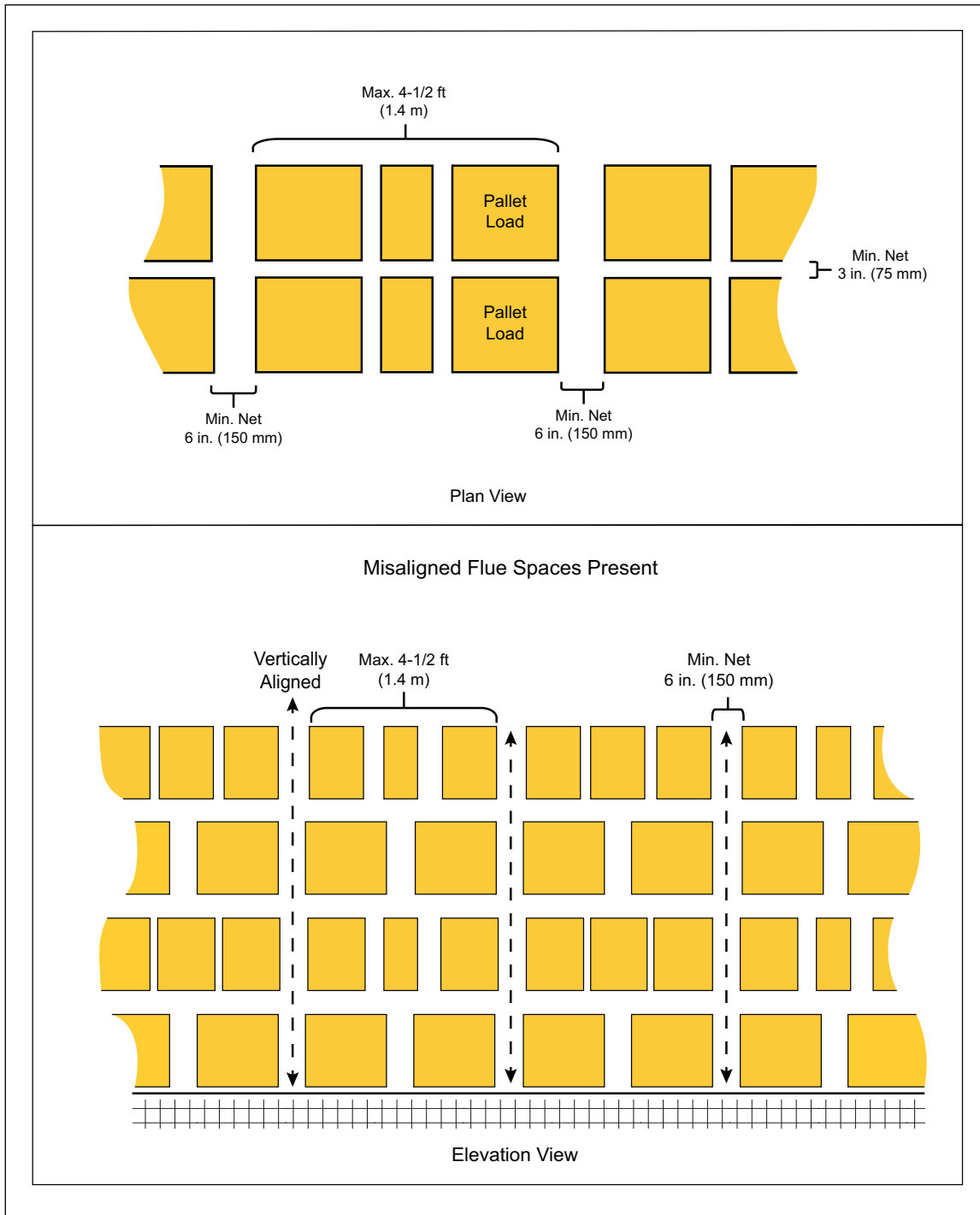

Fig. 2g. Acceptable flue space arrangement for double-row racks, Option 4

2.2.3.2.4 Multiple-Row Racks

2.2.3.2.4.1 See Section 2.2.3.2.1 if the multiple-row racks are provided with mesh, slatted, or solid shelving, as well as when rolled-type commodities are maintained within the multiple-row racks.

2.2.3.2.4.2 Flue spaces for multiple-row racks are considered adequate when:

- A. Racks void of any misaligned flue spaces throughout the entire height of the rack have minimum 6 in. (150 mm) wide longitudinal flue spaces a maximum of every 5 ft (1.5 m) as well as minimum 6 in. (150 mm) net wide transverse flue spaces a maximum of every 5 ft (1.5 m), as indicated in Figure 2h, or
- B. Racks are limited to a maximum depth of 20 ft (6.1 m), as defined by a minimum 8 ft (2.4 m) wide aisle, and have minimum 6 in. (150) net wide transverse flue spaces a maximum of every 5 ft (1.5 m), as indicated in Figure 2i.

2.2.3.2.4.3 Multiple-row racks can be treated as open-frame racks when:

- A. They qualify as open-frame racks per Section 2.2.3.2.1 (if applicable), and
- B. They have adequate flue spaces per Section 2.2.3.2.4.2

Otherwise, treat the multiple-row racks as racks with solid shelves. Determine the size of the solid shelf per Section 2.2.3.2.1.9.

2.2.3.2.4.4 When multiple-row racks are protected by in-rack sprinklers, flue spaces are not required for the tier level located directly above the in-rack sprinklers.

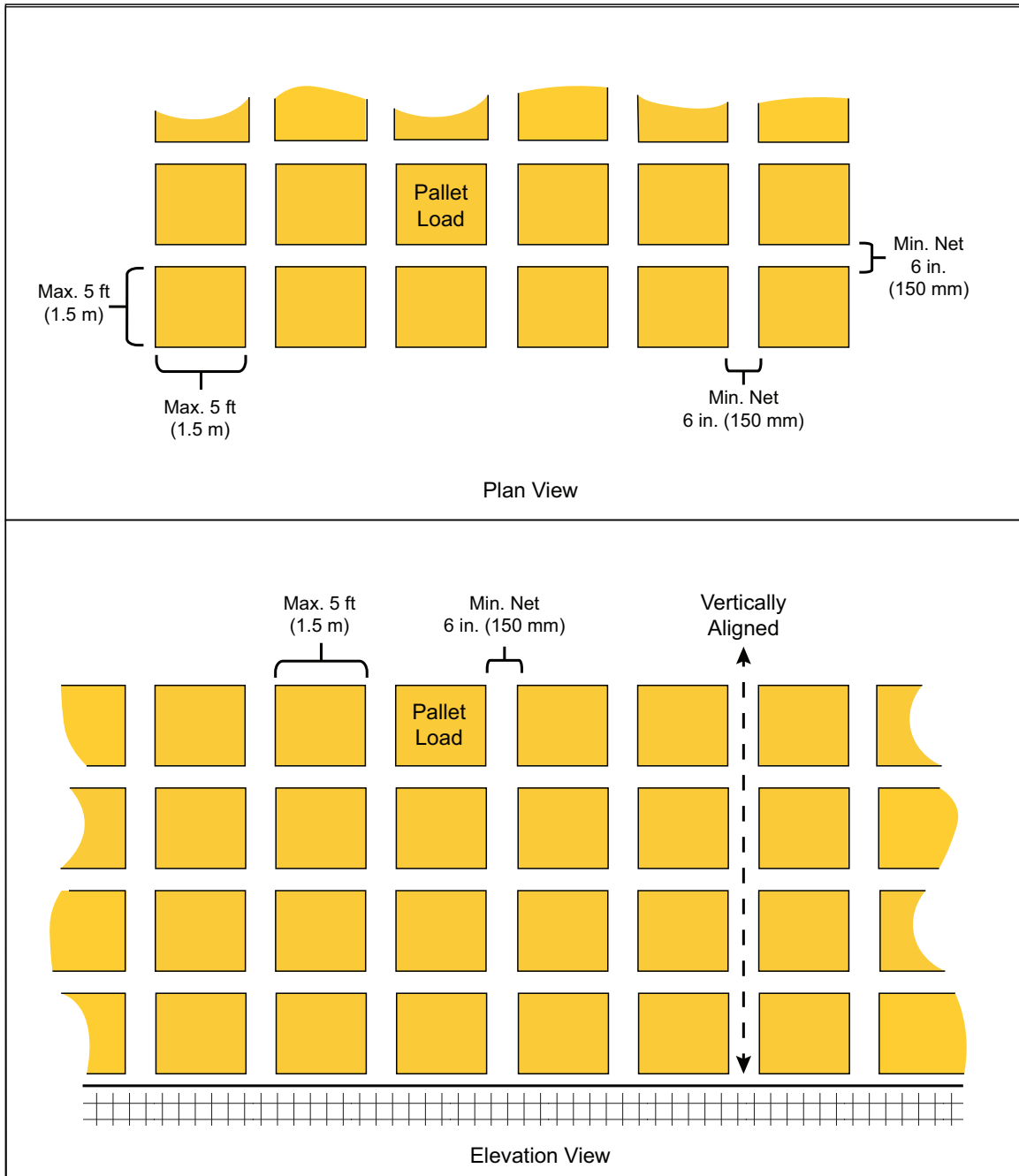

Fig. 2h. Acceptable transverse flue space arrangement for open-frame multiple-row racks, Option 1

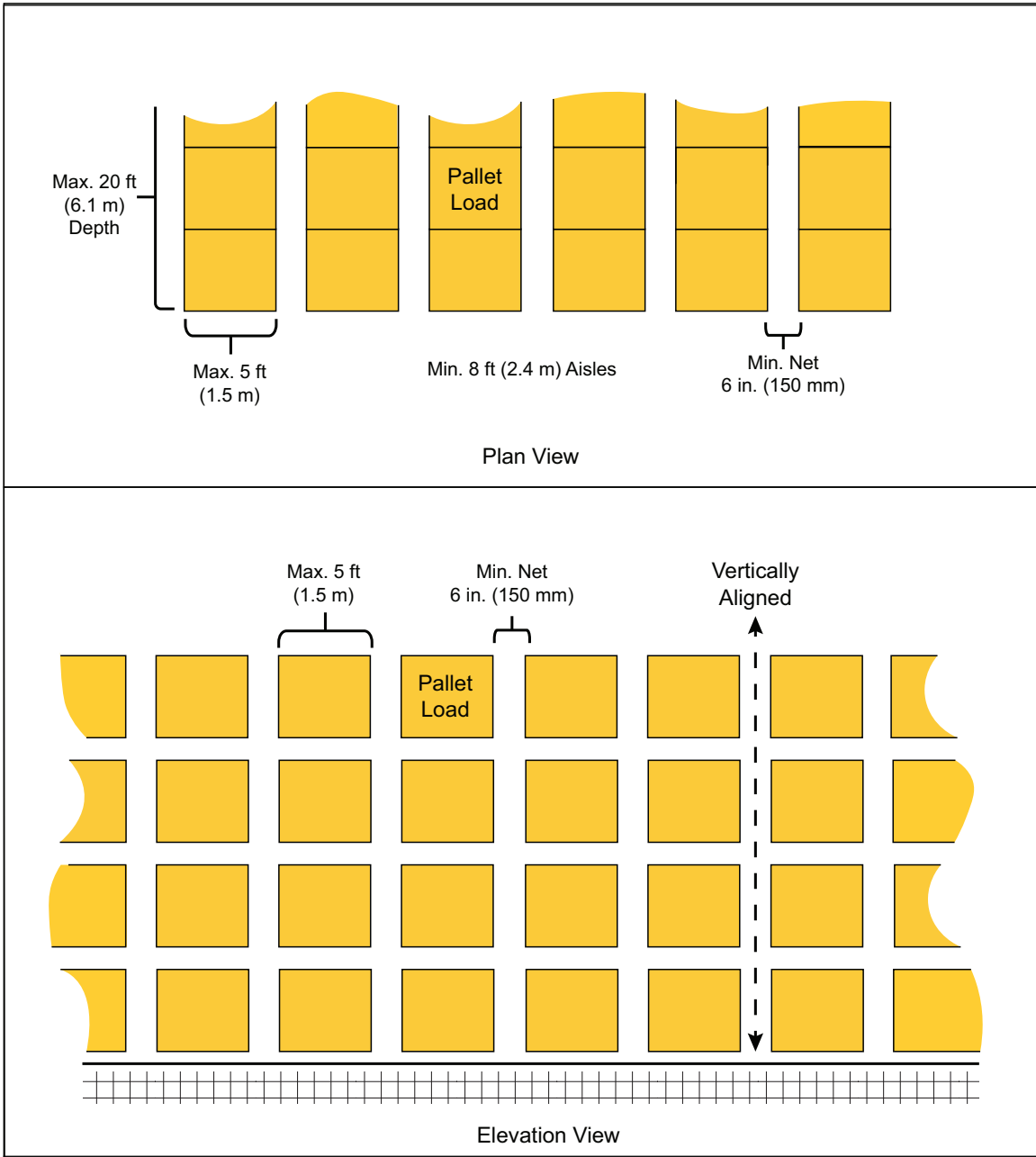

Fig. 2i. Acceptable transverse flue space arrangement for open-frame multiple-row racks, Option 2

2.2.3.3 Portable Racks

2.2.3.3.1 Portable racks with bottoms at least 70% open: Treat as open-frame rack storage as long as the storage within the portable rack (1) allows heat from a fire to vent vertically up through the portable rack, and (2) allows water to penetrate down through the portable rack, and (3) does not absorb water. Otherwise, treat the portable rack as having a solid bottom.

2.2.3.3.2 Portable racks with solid bottoms or bottoms less than 70% open: Limit the footprint size of a portable rack to a maximum of 20 ft² (2.0 m²) and provide minimum 3 in. (75 mm) wide flue spaces around all sides of the portable rack. Protect such a portable rack arrangement in accordance with the guidelines for open-frame rack storage as outlined in Section 2.3.3.7. As an alternative, limit the footprint size of a portable rack to a maximum of 40 ft² (4.0 m²) and equip the portable rack with three full-height, fixed-in-place, solid wooden or noncombustible sides that will inhibit horizontal fire spread. Protect such a portable rack arrangement in accordance with the guidelines for solid-piled storage as outlined in Section 2.3.3.7.

2.2.3.3.3 Treat portable racks that do not meet the guidelines in Sections 2.2.3.3.1 or 2.2.3.3.2 as rack storage having solid shelves. Size the shelf area using the guidelines for rack storage.

2.2.3.3.4 If ceiling-only protection options are not available from the applicable protection table, then limit the storage area of the portable racks to a maximum of 100 ft² (9.3 m²), as defined by a minimum 8 ft (2.4 m) wide clear space on all sides of the storage area, and limit the storage height to a maximum of 10 ft (3.0 m) for cartoned commodities or 5 ft (1.5 m) if the commodity hazard is uncartoned plastics. Base the automatic sprinkler system design requirements on the occupancy surrounding the portable storage instead of the portable storage itself.

2.2.3.4 Movable Racks

Protect rack storage in movable racks as multiple-row rack storage. Supply in-rack sprinklers (when required) via flexible in-rack sprinkler system connections, or other arrangements that provide sufficient water to the in-rack sprinklers.

2.2.4 Open-Top Containers Maintained in Storage Racks

2.2.4.1 Eliminating the Hazard Associated with Open-Top Noncombustible Containers Maintained in Storage Racks

2.2.4.1.1 Open-top noncombustible containers stored in racks can be treated as closed-top noncombustible containers when:

- A. All of the storage located below the open-top noncombustible containers is either noncombustible or in noncombustible containers, or
- B. All of the open-top noncombustible containers are located on the bottom tier of the storage rack.

2.2.4.1.2 When none of the guidelines in Section 2.2.4.1.1 are satisfied, protect the open-top noncombustible containers in accordance with Section 2.2.4.3.

2.2.4.2 Eliminating the Hazard Associated with Open-Top Combustible Containers Maintained in Storage Racks

2.2.4.2.1 Open-top combustible containers stored in racks can be treated as closed-top combustible containers when all open-top combustible containers are located on the bottom tier of the storage rack. Note, if the open-top containers are a higher commodity hazard than the storage located in the tier levels above them, this option is only applicable if the sprinkler protection is capable of adequately protecting these containers as if they were closed-top and stored throughout the entire height of the rack.

2.2.4.2.2 When the guidelines in Section 2.2.4.2.1 are not satisfied, protect the open-top combustible containers in accordance with Section 2.2.4.3.

2.2.4.3 Protection for Open-Top Containers Maintained in Storage Racks

2.2.4.3.1 Open-Frame Racks or Racks with Solid Shelves up to 64 ft² (6.0 m²) in Area

2.2.4.3.1.1 When the maximum storage height is 10 ft (3.0 m) or less, protect open-frame racks or racks that have solid shelves up to 64 ft² (6.0 m²) in area per Figure 2 as though 20 to 64 ft² (2.0 to 6.0 m²) solid shelves are present.

2.2.4.3.1.2 When the maximum storage height is greater than 10 ft (3.0 m), protect open-frame racks or racks that have solid shelves up to 64 ft² (6.0 m²) in area with in-rack sprinklers installed horizontally as follows:

- A. For single-row racks up to a maximum depth of 3 ft (0.9 m), install in-rack sprinklers per Figure 11, or
- B. For single-row racks over 3 ft (0.9 m) deep, install in-rack sprinklers per Figure 11a, or
- C. For double-row racks, install in-rack sprinklers per Figure 13, or
- D. For multiple-row racks install in-rack sprinklers per Figure 14.

2.2.4.3.1.3 When in-rack sprinklers are needed per Section 2.2.4.3.1.2, locate the in-rack sprinklers vertically as follows:

- A. When the worst-case commodity classification is Class 3, the in-rack sprinklers can be installed on maximum 15 ft (4.5 m) vertical increments, or
- B. When the worst-case commodity classification is greater than Class 3, install the in-rack sprinklers on maximum 10 ft (3.0 m) vertical increments.

Arrange the location of the in-rack sprinklers so that there is only a single pallet load of storage located above the top level of in-rack sprinklers.

2.2.4.3.1.4 Design the in-rack sprinklers to provide a minimum flow of 60 gpm (230 L/min) from the most remote in-rack sprinkler with the following number of in-rack sprinklers accounted for in the design:

- A. For single-row racks up to a maximum depth of 3 ft (0.9 m), include 4 sprinklers on each of the most remote two in-rack sprinkler levels (8 total in-rack sprinklers) in the design, or
- B. For single-row racks over 3 ft (0.9 m) deep, include 6 sprinklers on each of the most remote two in-rack sprinkler levels (12 total in-rack sprinklers) in the design, or
- C. For double-row and multiple-row racks, include 8 sprinklers on each of the most remote two in-rack sprinkler levels (16 total in-rack sprinklers) in the design.

2.2.4.3.1.5 See Section 2.3.4 for any additional design or installation guidelines for the in-rack sprinkler system not addressed in Section 2.2.4.3.1.

2.2.4.3.1.6 See Table 13 to determine the protection design for the ceiling sprinkler system, Table 1a for the guidelines on how to shape the demand area for hydraulic calculation purposes, and Table 14 for the hose stream allowance and combined ceiling and in-rack sprinkler system water supply duration.

2.2.4.3.1.7 Hydraulically balance the in-rack sprinkler system with the ceiling sprinkler system at their point of connection.

2.2.4.3.2 Racks with Solid Shelves over 64 ft² (6.0 m²) in Area

2.2.4.3.2.1 For single-row racks that have solid shelves greater than 64 ft² (6.0 m²) in area, install in-rack sprinklers horizontally as follows:

- A. For single-row racks up to a maximum depth of 3 ft (0.9 m), install in-rack sprinklers per Figure 11, or
- B. For single-row racks over 3 ft (0.9 m) deep and having transverse flue spaces a maximum of 5 ft (1.5 m) apart, in-rack sprinklers can be installed per Figures 2j or 11a, or
- C. For single-row racks over 3 ft (0.9 m) deep having transverse flue spaces more than 5 ft (1.5 m) apart, install in-rack sprinklers per Figure 11a.

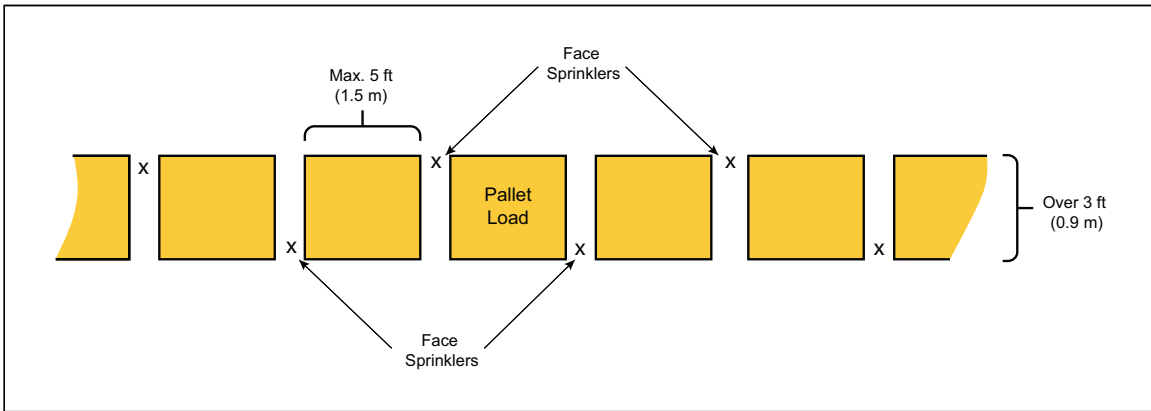

Fig. 2j. Horizontal in-rack sprinkler arrangement for indicated conditions when single-row racks deeper than 3 ft (0.9 m)

2.2.4.3.2.2 For double-row racks that have solid shelves greater than 64 ft² (6.0 m²) in area, install in-rack sprinklers horizontally as follows:

- A. For double-row racks having transverse flue spaces a maximum of 5 ft (1.5 m) apart, in-rack sprinklers can be installed per Figures 2k or 13, or
- B. For double-row racks having transverse flue spaces more than 5 ft (1.5 m) apart, install in-rack sprinklers per Figure 13.

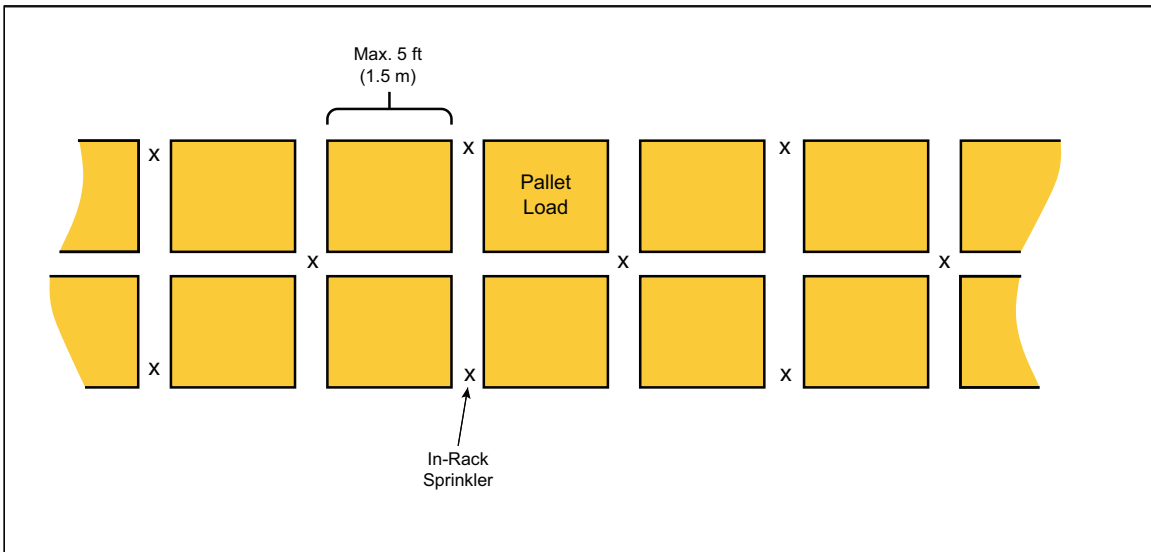

Fig. 2k. Horizontal in-rack sprinkler arrangement for open-top containers maintained in double-row racks having solid shelves greater than 64 ft² (6.0 m²) in area.

2.2.4.3.2.3 For multiple-row racks that have solid shelves greater than 64 ft² (6.0 m²) in area, install in-rack sprinklers horizontally in every transverse flue space as shown in Figure 10.

2.2.4.3.2.4 Install the in-rack sprinklers vertically at every tier level.

2.2.4.3.2.5 Design the in-rack sprinklers to provide a minimum flow of 30 gpm (115 L/min) from the most remote in-rack sprinkler with the following number of in-rack sprinklers accounted for in the design:

- A. For single-row racks up to a maximum depth of 3 ft (0.9 m), include 4 sprinklers on each of the most remote two in-rack sprinkler levels (8 total in-rack sprinklers) in the design, or

B. For single-row racks over 3 ft (0.9 m) deep, include 6 sprinklers on each of the most remote two in-rack sprinkler levels (12 total in-rack sprinklers) in the design, or

C. For double-row and multiple-row racks, include 8 sprinklers on each of the most remote two in-rack sprinkler levels (16 total in-rack sprinklers) in the design.

2.2.4.3.2.6 See Section 2.3.4 for any additional design or installation guidelines for the in-rack sprinkler system not addressed in Section 2.2.4.3.2.

2.2.4.3.2.7 See Table 13 to determine the protection design for the ceiling sprinkler system, Table 1a for the guidelines on how to shape the demand area for hydraulic calculation purposes, and Table 14 for the hose stream allowance and combined ceiling and in-rack sprinkler system water supply duration.

2.2.4.3.2.8 Hydraulically balance the in-rack sprinkler system with the ceiling sprinkler system at their point of connection.

2.2.5 Pallets

2.2.5.1 Use noncombustible or metal pallets whenever possible.

2.2.5.2 Include the combustibility of pallets in the overall commodity classification. Refer to Data Sheet 8-1, *Commodity Classification*, for a description of how this can be accomplished.

2.2.5.3 Protect the storage of idle pallets in accordance with the recommendations in Data Sheet 8-24, *Idle Pallet Storage*.

2.2.6 Clearance Between Top of Storage and Ceiling-Level Sprinkler Deflector

2.2.6.1 Maintain a minimum 3 ft (0.9 m) clearance between the top of the storage and the deflectors of standard-coverage ceiling-level sprinklers.

2.2.6.2 Maintain a minimum 5 ft (1.5 m) clearance between the top of the storage and the deflectors of extended-coverage ceiling-level sprinklers.

2.3 Protection

2.3.1 General

2.3.1.1 When determining the fire protection options for a storage facility, consider all the protection options the water supply can support. This approach will help maximize operational flexibility when considering potential future commodity changes and/or storage arrangements.

2.3.1.2 Regardless of the sprinkler system protection option chosen, it is imperative to coordinate a facility's construction, occupancy, and protection details in the planning stages so they are all compatible. It is critical that no objects between the top of storage and the ceiling-level sprinklers interfere with the sprinkler's proper discharge pattern. See Data Sheet 2-0, *Installation Guidelines for Automatic Sprinklers*, for guidelines related to obstructions of Storage sprinklers.

2.3.1.3 In addition to the recommendations in this data sheet, follow the sprinkler installation guidelines indicated for Storage sprinklers in Data Sheet 2-0, *Installation Guidelines for Automatic Sprinklers*.

2.3.1.4 Also, for facilities located in earthquake-prone regions, refer to FM Data Sheet 2-8, *Earthquake Protection for Water-Based Fire Protection Systems*.

2.3.2 Sprinkler System Types

Depending on the ambient temperature of the area being protected, sprinkler systems can be wet-pipe, dry-pipe, antifreeze solution, preaction, deluge, or refrigerated area. Note, however, that grid-type piping configurations are only recommended for wet-pipe and antifreeze solution sprinkler systems.

2.3.2.1 See Data Sheet 2-0, *Installation Guidelines for Automatic Sprinklers*, for additional guidelines related to the installation rules for all sprinkler system types and additional guidelines related to the installation rules for refrigerated area sprinkler systems.

2.3.2.2 See Data Sheet 5-48, *Automatic Fire Detection*, for guidelines related to the installation of detection devices for pre-action and deluge type sprinkler systems.

2.3.2.3 Unless indicated otherwise in this data sheet, base water demands for antifreeze solution sprinkler systems on wet-pipe systems.

2.3.2.4 Base water demands for single-interlocked preaction sprinkler systems on either wet-pipe or dry-pipe systems, depending on the spacing of the heat detection devices located at the ceiling. See Data Sheet 5-48, *Automatic Fire Detection*, to determine the system type based on detector spacing. Base the design for all other preaction sprinkler system types on the designs indicated for dry-pipe systems.

2.3.2.5 Unless indicated otherwise in this data sheet, the maximum water delivery time for all dry-pipe and similar sprinkler systems is 40 seconds. For unobstructed ceiling construction, this maximum water delivery time is based on the operation of the most remote 4 sprinklers (2 sprinklers on 2 lines); for obstructed ceiling construction, it is based on the most remote 2 sprinklers (2 sprinklers on 1 line). For cut-off areas protected by a single sprinkler, the maximum water delivery time is 60 seconds.

2.3.3 Ceiling-Level Storage Sprinklers

2.3.3.1 General

FM Approved sprinklers for storage occupancy hazards and other similar high heat-release type fires are listed in the *Approval Guide*, an online resource of FM Approvals, under the heading of Storage Sprinklers (Ceiling-Level) or Storage Sprinklers (In-Racks). This section will discuss recommendations for FM Approved ceiling-level Storage sprinklers.

2.3.3.1.1 See Section 2.3.3.7 and Section 2.3.6 for the protection design guidelines of ceiling-level Storage sprinklers. Tables 2 through 6, 14a, 14b, and 17b provide design guidelines for solid-piled, palletized, shelf, and bin-box storage arrangements. The design guidelines for open-frame rack storage arrangements are provided in Tables 7 through 11, 14a, 14b, and 17b. See the flowchart in Figure 3 if storage racks have, or must be protected as if they have solid shelves, to determine if in-rack sprinklers are recommended.

2.3.3.1.2 Follow the guidelines in Data Sheet 2-0, *Installation Guidelines for Automatic Sprinklers*, for the installation of ceiling-level Storage sprinklers.

2.3.3.2 K-Factors, Nominal Temperature Rating, RTI Rating, and the Orientation of Ceiling-Level Storage Sprinklers

2.3.3.2.1 Use only FM Approved sprinklers listed in the *Approval Guide* under the heading of Storage Sprinklers (Ceiling-Level) for any ceiling-level sprinkler options in this data sheet.

Currently, FM Approved ceiling-level Storage sprinklers have K-factor values ranging from 11.2 (160) to 33.6 (480). See Appendix A for a definition of K-factor as well as the units used for its indicated value.

Note that the following sprinklers are not FM Approved as ceiling-level Storage sprinklers:

- K8.0 (K115) and smaller
- On-Off type sprinklers
- ECLH type sprinklers
- ECOH type sprinklers

2.3.3.2.2 Unless indicated otherwise in this data sheet, use 160°F (70°C) nominal temperature rated, ceiling-level sprinklers in sprinkler systems that can be treated as wet-pipe. Use 212°F (100°C) nominal temperature rated ceiling-level sprinklers when the ambient temperature will exceed 100°F (38°C). When 212°F (100°C) rated sprinklers are required due to ambient temperature conditions, treat their presence the same as 160°F (70°C) rated sprinklers for design purposes. See Appendix A for a definition of nominal temperature rating as well as the temperature ranges each nominal value represents.

2.3.3.2.3 Unless indicated otherwise in this data sheet, use 280°F (140°C) nominal temperature rated ceiling-level sprinklers in dry-pipe, refrigerated area, or equivalent type systems.

2.3.3.2.4 Use ceiling-level sprinklers equipped with a quick-response thermal sensing element only in wet-pipe and antifreeze solution sprinkler systems unless recommended otherwise for specific applications in this data sheet.

2.3.3.2.5 Ceiling-level sprinklers equipped with standard-response thermal sensing elements can be used for wet-pipe, dry-pipe, antifreeze solution, preaction, and refrigerated area sprinkler systems unless indicated otherwise in this data sheet.

2.3.3.2.6 Use pendent ceiling-level sprinklers in wet-pipe or antifreeze solution systems only. Upright ceiling-level sprinklers can be used for wet-pipe, dry-pipe, antifreeze solution, preaction, and refrigerated area systems unless indicated otherwise in this data sheet.

2.3.3.2.7 Use dry-pendent ceiling-level sprinklers in wet-pipe or anti-freeze solution systems only. Design and installation requirements for dry-pendent sprinklers are based on those for a wet system using ceiling-level sprinklers having the same K-factor, RTI rating, sprinkler spacing coverage and temperature rating as the dry-pendent sprinkler.

2.3.3.3 Spacing of Ceiling-Level Storage Sprinklers

2.3.3.3.1 Install ceiling-level Storage sprinklers under unobstructed ceiling construction in accordance with the linear and area spacing guidelines in Table 1, unless indicated otherwise in this data sheet. See Data Sheet 2-0, *Installation Guidelines for Automatic Sprinklers*, for ceiling-level sprinkler spacing guidelines under obstructed ceiling construction.

Table 1. Spacing of Ceiling-Level Storage Sprinklers Under Unobstructed Ceiling Construction

| Ceiling Height, ft (m) | Sprinkler K-Factor | Sprinkler Orientation | Sprinkler Response | Sprinkler Linear Spacing, ft (m) | | Sprinkler Area Spacing, ft ² (m ²) | |
|------------------------|--|-----------------------|--------------------|----------------------------------|----------|---|------------|
| | | | | Min. | Max. | Min. | Max. |
| Up to 30 (9.0) | 11.2 (160) | Pendent or Upright | Quick or Standard | 8 (2.4) | 12 (3.6) | 80 (7.5) | 100 (9.0) |
| | 14.0 (200), 16.8 (240), 19.6 (280), 22.4 (320), 25.2 (360), 28.0 (400), 33.6 (480) | Pendent | Quick or Standard | 8 (2.4) | 12 (3.6) | 64 (6.0) | 100 (9.0) |
| | | | Quick | 8 (2.4) | 12 (3.6) | 64 (6.0) | 100 (9.0) |
| | | Standard | 8 (2.4) | 12 (3.6) | 80 (7.5) | 100 (9.0) | |
| | 25.2EC (360EC) | Pendent or Upright | Quick | 10 (3.0) | 14 (4.2) | 100 (9.0) | 196 (18.0) |
| Over 30 (9.0) | 11.2 (160) | Pendent or Upright | Quick or Standard | 8 (2.4) | 10 (3.0) | 80 (7.5) | 100 (9.0) |
| | 14.0 (200), 16.8 (240), 19.6 (280), 22.4 (320), 25.2 (360), 28.0 (400), 33.6 (480) | Pendent or Upright | Quick | 8 (2.4) | 10 (3.0) | 64 (6.0) | 100 (9.0) |
| | | | Standard | 8 (2.4) | 10 (3.0) | 80 (7.5) | 100 (9.0) |
| | 25.2EC (360EC) | Pendent or Upright | Quick | 10 (3.0) | 14 (4.2) | 100 (9.0) | 196 (18.0) |

2.3.3.4 Minimum Recommended Pressures for Ceiling-Level Storage Sprinklers

The sprinkler system designs in this data sheet for ceiling-level sprinklers are based on an indicated minimum operating pressure for a given sprinkler K-factor. As a result, base the minimum required ceiling-level sprinkler pressure on the value indicated in the applicable protection table for the commodity hazard, storage arrangement, and ceiling height involved.

2.3.3.5 Extension of Hydraulic Design

Extend the hydraulic design for storage occupancies at least one branchline or sprinkler beyond all edges of the storage, or to a wall, whenever there is mixed-use occupancy. Whenever two adjacent storage occupancies are protected differently, extend the design for the higher hazard one branchline or sprinkler into the lower hazard area. See Figure 2I for a visual demonstration of this guidance.

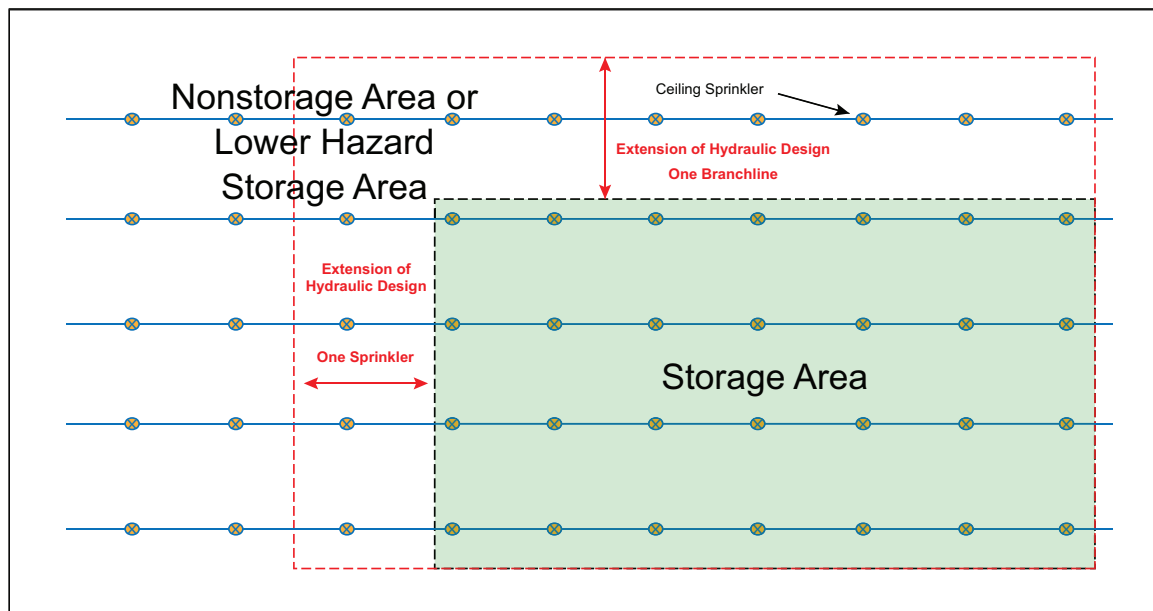

Fig. 21. Extension of hydraulic design

2.3.3.6 Mixing Different Ceiling-Level Storage Sprinklers Within the Same Protected Area

2.3.3.6.1 For a sprinkler system protecting a storage occupancy, install ceiling-level Storage sprinklers having the same K-factor, orientation, response time index (RTI) rating, and temperature rating throughout the sprinkler system, whenever possible.

2.3.3.6.2 Do not mix different types of sprinklers (e.g., Storage and Non-Storage sprinklers) on the same ceiling-level sprinkler system within the same protected area unless indicated otherwise by this data sheet.

2.3.3.6.3 Do not mix sprinklers having different K-factors on the same ceiling-level sprinkler system within the same protected area unless indicated otherwise by this data sheet.

2.3.3.6.4 Do not mix sprinklers having different orientations (i.e., pendent and upright) on the same ceiling-level sprinkler system within the same protected area unless indicated otherwise by this data sheet. See Data Sheet 2-0, *Installation Guidelines for Automatic Sprinklers*, for recommendations regarding the mixing of pendent and upright sprinklers on the same ceiling-level sprinkler system for the purpose of eliminating obstruction to sprinkler discharge.

2.3.3.6.5 Do not mix sprinklers having different response time index (RTI) ratings (i.e., quick-response and standard-response) on the same ceiling-level sprinkler system within the same protected area unless a clear delineation between the area protected by quick-response sprinklers and the area protected by standard-response sprinklers can be provided. When mixing quick-response and standard-response sprinklers at ceiling-level cannot be avoided, a draft curtain is needed:

- When the roofs over the two areas are at the same elevation, or
- When the quick-response ceiling-level sprinklers are at a higher elevation than the standard-response ceiling-level sprinklers

See the guidelines in Data Sheet 1-10, *Interaction of Sprinklers, Smoke and Heat Vents, and Draft Curtains*, regarding the installation guidelines of a draft curtain and the minimum clear space recommended below it.

2.3.3.6.6 Do not mix sprinklers having different nominal temperature ratings (i.e., 160°F [70°C] and 280°F [140°C]) on the same ceiling-level sprinkler system within the same protected area unless indicated otherwise within this data sheet. Note that mixing sprinklers having different nominal temperature ratings on the same ceiling-level sprinkler system is acceptable when ambient conditions, such as the immediate area around unit heaters, require a higher temperature-rated sprinkler to avoid the potential for premature operation.

2.3.3.7 Ceiling-Level Sprinkler System Design Criteria

2.3.3.7.1 General

The ceiling-level protection options in this data sheet are provided in Tables 2 through 11, 14a, 14b, and 17b as follows:

- Table 2: Ceiling-Level Protection Guidelines for Class 1, 2 and 3 Commodities in a Solid-Piled, Palletized, Shelf, or Bin-Box Storage Arrangement
- Table 3: Ceiling-Level Protection Guidelines for Class 4 and Cartoned Unexpanded Plastic Commodities in a Solid-Piled, Palletized, Shelf, or Bin-Box Storage Arrangement
- Table 4: Ceiling-Level Protection Guidelines for Cartoned Expanded Plastic Commodities in a Solid-Piled, Palletized, Shelf, or Bin-Box Storage Arrangement
- Table 5: Ceiling-Level Protection Guidelines for Uncartoned Unexpanded Plastic Commodities in a Solid-Piled, Palletized, Shelf, or Bin-Box Storage Arrangement
- Table 6: Ceiling-Level Protection Guidelines for Uncartoned Expanded Plastic Commodities in a Solid-Piled, Palletized, Shelf, or Bin-Box Storage Arrangement
- Table 7: Ceiling-Level Protection Guidelines for Class 1, 2 and 3 Commodities in Open-Frame Rack Storage Arrangements
- Table 8: Ceiling-Level Protection Guidelines for Class 4 and Cartoned Unexpanded Plastic Commodities in Open-Frame Rack Storage Arrangements
- Table 9: Ceiling-Level Protection Guidelines for Cartoned Expanded Plastic Commodities in Open-Frame Rack Storage Arrangements
- Table 10: Ceiling-Level Protection Guidelines for Uncartoned Unexpanded Plastic Commodities in Open-Frame Rack Storage Arrangements
- Table 11: Ceiling-Level Protection Guidelines for Uncartoned Expanded Plastic Commodities in Open-Frame Rack Storage Arrangements
- Table 14a: Ceiling-Level Sprinkler System Designs for Class 1 and 2 Commodities Protected by Dry-Pipe and Similar Sprinkler Systems
- Table 14b: Ceiling-Level Sprinkler System Designs for Class 3 Commodities Protected by Dry-Pipe and Similar Sprinkler Systems
- Table 17b: Quick-Response, 160°F (70°C) Nominally Rated, Standard-Coverage Pendent Storage Sprinkler Ceiling-Only Designs for Ceiling Heights Over 40 ft (12.0 m)

The ceiling-level designs listed within these tables are provided to either (1) achieve suppression like performance, or (2) when suppression like performance is not available offer the lowest allowable pressure for design purposes. If a design listed for a higher ceiling height hydraulically offers a better option than for the design indicated for the ceiling height of the storage area, the design for the higher ceiling height can be utilized.

In each table, the ceiling-level protection options highlighted in green represent those for which the hose stream demand is 250 gpm (950 L/min) and the duration is 1 hour. These highlighted options have the potential result in less fire, smoke, and water damage than other acceptable options and thus may, from a sustainability standpoint, be preferable.

See Section 2.3.2.5 regarding the water delivery time requirements for the protection options offered in Tables 2 through 11 for dry-pipe type systems.

The design guidelines for ceiling-level Storage sprinklers are based on five main attributes assigned to a sprinkler. They are:

- K-Factor (orifice size)
- Orientation (pendent or upright)
- Response time index rating (quick-response or standard-response)

- Nominal temperature rating
- Sprinkler spacing (standard or extended-coverage)

Once the commodity hazard, storage arrangement, and peak ceiling height for the protected area is known, the protection design options for the sprinkler system can be determined using the appropriate protection table in combination with the five sprinkler attributes.

2.3.3.7.1.1 See the flowchart in Figure 3 to determine if in-rack sprinklers are recommended for storage racks provided with solid shelves.

2.3.3.7.1.2 See Section 2.3.3.7.3.2 when ceiling heights exceed those indicated in Tables 2 through 6, 14a, 14b, or 17b.

2.3.3.7.1.3 See Section 2.3.3.7.3.1 when ceiling heights exceed those indicated in Tables 7 through 11, 14a, 14b, or 17b.

2.3.3.7.1.4 If a ceiling-only protection option is available and is chosen for installation, see Section 2.3.5 to determine the hose demand and the duration needed for the sprinkler system design.

2.3.3.7.1.5 If a combination ceiling and in-rack sprinkler system is chosen for installation, see Section 2.3.4.8 to determine the requirements for the combined in-rack and ceiling-level sprinkler system.

2.3.3.7.2 Ceiling-Level Design Guidelines

The ceiling-level protection design guidelines listed in Tables 2 through 11, 14a, 14b, and 17b use a design format based on an indicated number of operating sprinklers at a given minimum sprinkler operating pressure. Do not interpolate or make adjustments to the values listed in these tables.

2.3.3.7.2.1 To determine the protection options available, find the appropriate protection table based on commodity hazard, ceiling height, and storage arrangement. If the storage arrangement is racks with solid shelves or racks that must be protected as if they have solid shelves, see the flowchart in Figure 3 to determine if in-rack sprinklers are recommended.

2.3.3.7.2.2 Once the appropriate table has been chosen, the available protection options can be determined based on the maximum ceiling height of the protected area and the type of sprinkler system (wet or dry) to be installed. The ceiling-level sprinkler system design can be based on any ceiling height from the protection table that is equal to or higher than the maximum ceiling height of the protected area.

2.3.3.7.2.3 The minimum design area (i.e. the number of sprinklers in the design multiplied by the spacing of the sprinklers) is 768 ft² (71 m²), except when sprinklers are required in every channel created by obstructed construction. When the design area is less than 768 ft² (71 m²) and sprinklers are not required in every channel, increase the number of sprinklers in the ceiling design, as needed, to meet this minimum design area. Note that the hose demand and water supply duration requirements from Table 14 are not based on the number of sprinklers required per this section, but rather are based on the number of sprinklers indicated in the design obtained from the applicable protection table.

2.3.3.7.2.4 The units for K-factor values given in Tables 2 through 11 are gpm/psi^{0.5} ([L/min]/bar^{0.5}).

2.3.3.7.2.5 For a given storage arrangement, commodity hazard and ceiling height, ceiling-level protection options for pendent sprinklers can also be based on those listed for upright sprinklers having the same K-factor, RTI rating, nominal temperature rating and linear/area spacing requirements.

2.3.3.7.2.6 Use Table 1a to determine the number of ceiling-level sprinklers per branchline to include for hydraulic calculation purposes. When using Equation 1 or Equation 2, if the result is not a whole number, round to the nearest whole number using normal rounding methods (i.e., round down for 0.49 or less; round up for 0.50 and greater).

Table 1a. Determining Number of Sprinklers per Branchline for Ceiling Sprinkler System Hydraulic Design

| No. of Sprinklers in Ceiling Design | Ceiling Sprinkler Type | Ceiling Slope | Ceiling Sprinkler On-Line Spacing, ft (m) | Number of Sprinklers per Branchline in Demand Area |
|-------------------------------------|------------------------|-----------------|---|--|
| 6 | Extended Coverage | $\leq 10^\circ$ | Any | 3 |
| 8 | Extended Coverage | $\leq 5^\circ$ | $\leq 12 (3.7)$ | 4 |
| | | | $> 12 (3.7)$ | 3 |
| | | $\leq 10^\circ$ | Any | 4 |
| 9 | Standard Coverage | $\leq 10^\circ$ | Any | 3 |
| | Extended Coverage | $\leq 10^\circ$ | Any | 4 |
| 10 | Standard Coverage | $\leq 5^\circ$ | $< 10 (3.0)$ | 4 |
| | | | $\geq 10 (3.0)$ | 3 |
| | Extended Coverage | $\leq 5^\circ$ | Any | See Equation 1 |
| | | $\leq 10^\circ$ | Any | See Equation 2 |
| 12 | Standard Coverage | $\leq 10^\circ$ | Any | 4 |
| | Extended Coverage | $\leq 5^\circ$ | Any | See Equation 1 |
| | | $\leq 10^\circ$ | Any | See Equation 2 |
| > 12 | Any | $\leq 5^\circ$ | Any | See Equation 1 |
| | Any | $\leq 10^\circ$ | Any | See Equation 2 |

Equation 1: Number of Sprinklers per Branchline in Demand Area, Ceiling Slope $\leq 5^\circ$

$$(1.2 / S_{MAX}) \times \text{SQRT} ([\text{Number of Sprinklers in Ceiling Design} \times S_{MAX} \times L_{MAX}])$$

Where:

S_{MAX} = Maximum on-line spacing used within the calculated sprinkler system.

L_{MAX} = Maximum between line spacing used within the calculated sprinkler system.

Equation 2: Number of Sprinklers per Branchline in Demand Area, $5^\circ < \text{Ceiling Slope} \leq 10^\circ$

$$(1.4 / S_{MAX}) \times \text{SQRT} ([\text{Number of Sprinklers in Ceiling Design} \times S_{MAX} \times L_{MAX}])$$

Where:

S_{MAX} = Maximum on-line spacing used within the calculated sprinkler system.

L_{MAX} = Maximum between line spacing used within the calculated sprinkler system.

Table 2. Ceiling-Level Protection Guidelines for Class 1, 2, and 3 Commodities in a Solid-Piled, Palletized, Shelf, or Bin-Box Storage Arrangement

| Max. Ceiling Height, ft (m) | Wet System, 160°F (70°C) Nominally Rated, Pendent Sprinklers | | | | | | | | | | Wet System, 160°F (70°C) Nominally Rated, Upright Sprinklers | | | | | | Dry System, 280°F (140°C) Nominally Rated, Upright Sprinklers | | | |
|-----------------------------|--|---------------|---------------|--------------|--------------|---------------------------|-------------------|---------------|---------------|--------------|--|---------------|---------------|------------------|-------------------|---------------|---|---------------------|---------------|---------------|
| | Quick Response | | | | | | Standard Response | | | | Quick Response | | | | Standard Response | | Standard Response | | | |
| | K11.2 (K160) | K14.0 (K200) | K16.8 (K240) | K22.4 (K320) | K25.2 (K360) | K25.2EC (K360EC) | K11.2 (K160) | K14.0 (K200) | K19.6 (K280) | K25.2 (K360) | K11.2 (K160) | K14.0 (K200) | K16.8 (K240) | K25.2EC (K360EC) | K11.2 (K160) | K16.8 (K240) | K25.2 (K360) | K11.2 (K160) | K16.8 (K240) | K25.2 (K360) |
| 10 (3.0) | 12 @ 7 (0.5) | 9 @ 7 (0.5) | 9 @ 7 (0.5) | 9 @ 20 (1.4) | 9 @ 20 (1.4) | 6 @ 20 (1.4) | 12 @ 7 (0.5) | 9 @ 7 (0.5) | 9 @ 16 (1.1) | 9 @ 7 (0.5) | 12 @ 7 (0.5) | 9 @ 7 (0.5) | 9 @ 7 (0.5) | 6 @ 20 (1.4) | 12 @ 7 (0.5) | 9 @ 7 (0.5) | 9 @ 7 (0.5) | 16 @ 7 (0.5) | 16 @ 7 (0.5) | 16 @ 7 (0.5) |
| 20 (6.0) | 12 @ 10 (0.7) | 12 @ 7 (0.5) | 12 @ 7 (0.5) | 9 @ 20 (1.4) | 9 @ 20 (1.4) | 6 @ 20 (1.4) | 12 @ 10 (0.7) | 12 @ 7 (0.5) | 9 @ 16 (1.1) | 9 @ 7 (0.5) | 12 @ 10 (0.7) | 12 @ 7 (0.5) | 12 @ 7 (0.5) | 6 @ 20 (1.4) | 12 @ 10 (0.7) | 12 @ 7 (0.5) | 9 @ 7 (0.5) | 16 @ 10 (0.7) | 16 @ 7 (0.5) | 16 @ 7 (0.5) |
| 25 (7.5) | 10 @ 30 (2.1) | 10 @ 20 (1.4) | 10 @ 13 (0.9) | 9 @ 20 (1.4) | 9 @ 20 (1.4) | 6 @ 20 (1.4) | 10 @ 30 (2.1) | 10 @ 20 (1.4) | 9 @ 16 (1.1) | 10 @ 7 (0.5) | 10 @ 30 (2.1) | 10 @ 20 (1.4) | 10 @ 13 (0.9) | 6 @ 20 (1.4) | 10 @ 30 (2.1) | 10 @ 13 (0.9) | 10 @ 7 (0.5) | 20 @ 16 (1.1) | 20 @ 7 (0.5) | 20 @ 7 (0.5) |
| 30 (9.0) | 18 @ 50 (3.5) | 12 @ 50 (3.5) | 12 @ 35 (2.4) | 9 @ 20 (1.4) | 9 @ 20 (1.4) | 6 @ 25 (1.7) | 18 @ 50 (3.5) | 18 @ 32 (2.2) | 9 @ 16 (1.1) | 9 @ 10 (0.7) | 18 @ 50 (3.5) | 12 @ 50 (3.5) | 12 @ 35 (2.4) | 6 @ 25 (1.7) | 18 @ 50 (3.5) | 18 @ 22 (1.5) | 12 @ 20 (1.4) | 25 @ 50 (3.5) | 25 @ 22 (1.5) | 25 @ 10 (0.7) |
| 35 (10.5) | | 9 @ 75 (5.2) | 9 @ 52 (3.6) | 9 @ 28 (1.9) | 9 @ 22 (1.5) | 6 @ 60 (4.1) ^a | | | 15 @ 25 (1.7) | 9 @ 30 (2.1) | | 9 @ 75 (5.2) | 9 @ 52 (3.6) | 8 @ 40 (2.8) | | | | See Section 2.3.6.1 | | |
| 40 (12.0) | | 9 @ 75 (5.2) | 9 @ 52 (3.6) | 9 @ 28 (1.9) | 9 @ 22 (1.5) | | | | | 9 @ 30 (2.1) | | | | | | | | | | |

^a An acceptable alternative design is 8 @ 40 (2.8) when a 12 ft (3.6 m) maximum linear spacing is used

Table 3. Ceiling-Level Protection Guidelines for Class 4 and Cartoned Unexpanded Plastic Commodities in a Solid-Piled, Palletized, Shelf, or Bin-Box Storage Arrangement

| Protection of Class 4 and Cartoned Unexpanded Plastic Commodities in Solid-Piled, Palletized, Shelf, and Bin-Box Arrangements; No. of AS @ psi (bar) | | | | | | | | | | | | | | | | | | | | |
|--|--|---------------|---------------|--------------|--------------|---------------------------|---------------|---------------|---------------|--------------|--|---------------|---------------|------------------|-------------------|---------------|---|---------------|---------------|---------------|
| Max. Ceiling Height, ft (m) | Wet System, 160°F (70°C) Nominally Rated, Pendent Sprinklers | | | | | | | | | | Wet System, 160°F (70°C) Nominally Rated, Upright Sprinklers | | | | | | Dry System, 280°F (140°C) Nominally Rated, Upright Sprinklers | | | |
| | Quick Response | | | | | Standard Response | | | | | Quick Response | | | | Standard Response | | Standard Response | | | |
| | K11.2 (K160) | K14.0 (K200) | K16.8 (K240) | K22.4 (K320) | K25.2 (K360) | K25.2EC (K360EC) | K11.2 (K160) | K14.0 (K200) | K19.6 (K280) | K25.2 (K360) | K11.2 (K160) | K14.0 (K200) | K16.8 (K240) | K25.2EC (K360EC) | K11.2 (K160) | K16.8 (K240) | K25.2 (K360) | K11.2 (K160) | K16.8 (K240) | K25.2 (K360) |
| 10 (3.0) | 12 @ 7 (0.5) | 9 @ 7 (0.5) | 9 @ 7 (0.5) | 9 @ 20 (1.4) | 9 @ 20 (1.4) | 6 @ 20 (1.4) | 12 @ 7 (0.5) | 9 @ 7 (0.5) | 9 @ 16 (1.1) | 9 @ 7 (0.5) | 12 @ 7 (0.5) | 9 @ 7 (0.5) | 9 @ 7 (0.5) | 6 @ 20 (1.4) | 12 @ 7 (0.5) | 9 @ 7 (0.5) | 9 @ 7 (0.5) | 16 @ 7 (0.5) | 16 @ 7 (0.5) | 16 @ 7 (0.5) |
| 15 (4.5) | 12 @ 15 (1.0) | 12 @ 10 (0.7) | 12 @ 7 (0.5) | 9 @ 20 (1.4) | 9 @ 20 (1.4) | 6 @ 20 (1.4) | 12 @ 15 (1.0) | 12 @ 10 (0.7) | 9 @ 16 (1.1) | 10 @ 7 (0.5) | 12 @ 15 (1.0) | 12 @ 10 (0.7) | 12 @ 7 (0.5) | 6 @ 20 (1.4) | 12 @ 15 (1.0) | 12 @ 7 (0.5) | 10 @ 7 (0.5) | 16 @ 20 (1.4) | 16 @ 7 (0.5) | 16 @ 7 (0.5) |
| 20 (6.0) | 10 @ 30 (2.1) | 10 @ 20 (1.4) | 10 @ 13 (0.9) | 9 @ 20 (1.4) | 9 @ 20 (1.4) | 6 @ 20 (1.4) | 10 @ 30 (2.1) | 10 @ 20 (1.4) | 9 @ 16 (1.1) | 10 @ 7 (0.5) | 10 @ 30 (2.1) | 10 @ 20 (1.4) | 10 @ 13 (0.9) | 6 @ 20 (1.4) | 10 @ 30 (2.1) | 10 @ 13 (0.9) | 10 @ 7 (0.5) | 16 @ 30 (2.1) | 16 @ 13 (0.9) | 16 @ 7 (0.5) |
| 25 (7.5) | 10 @ 30 (2.1) | 10 @ 20 (1.4) | 10 @ 13 (0.9) | 9 @ 20 (1.4) | 9 @ 20 (1.4) | 6 @ 20 (1.4) | 10 @ 30 (2.1) | 10 @ 20 (1.4) | 9 @ 16 (1.1) | 10 @ 7 (0.5) | 10 @ 30 (2.1) | 10 @ 20 (1.4) | 10 @ 13 (0.9) | 6 @ 20 (1.4) | 10 @ 30 (2.1) | 10 @ 13 (0.9) | 10 @ 7 (0.5) | 20 @ 30 (2.1) | 20 @ 13 (0.9) | 20 @ 7 (0.5) |
| 30 (9.0) | 25 @ 50 (3.5) | 12 @ 50 (3.5) | 12 @ 35 (2.4) | 9 @ 20 (1.4) | 9 @ 20 (1.4) | 6 @ 30 (2.1) | 25 @ 50 (3.5) | 25 @ 32 (2.2) | 9 @ 16 (1.1) | 9 @ 10 (0.7) | 25 @ 50 (3.5) | 12 @ 50 (3.5) | 12 @ 35 (2.4) | 6 @ 30 (2.1) | 25 @ 50 (3.5) | 25 @ 22 (1.5) | 12 @ 20 (1.4) | 30 @ 50 (3.5) | 30 @ 22 (1.5) | 30 @ 10 (0.7) |
| 35 (10.5) | | 9 @ 75 (5.2) | 9 @ 52 (3.6) | 9 @ 28 (1.9) | 9 @ 22 (1.5) | 6 @ 60 (4.1) ^a | | | 15 @ 25 (1.7) | 9 @ 30 (2.1) | | 12 @ 75 (5.2) | 12 @ 52 (3.6) | 8 @ 40 (2.8) | | | | | | |
| 40 (12.0) | | 9 @ 75 (5.2) | 9 @ 52 (3.6) | 9 @ 28 (1.9) | 9 @ 22 (1.5) | | | | | 9 @ 30 (2.1) | | | | | | | | | | |

^a An acceptable alternative design is 8 @ 40 (2.8) when a 12 ft (3.6 m) maximum linear spacing is used

Table 4. Ceiling-Level Protection Guidelines for Cartoned Expanded Plastic Commodities in a Solid-Piled, Palletized, Shelf, or Bin-Box Storage Arrangement

| Max. Ceiling Height, ft (m) | Protection of Cartoned Expanded Plastic Commodities in Solid-Piled, Palletized, Shelf, and Bin-Box Arrangements; No. of AS @ psi (bar) | | | | | | | | | | | | | | | | | | | |
|-----------------------------|--|---------------|---------------|---------------|---------------|------------------|-------------------|---------------|---------------|--|---------------|---------------|---------------|-------------------|---------------|---|---------------|---------------|---------------|---------------|
| | Wet System, 160°F (70°C) Nominally Rated, Pendent Sprinklers | | | | | | | | | Wet System, 160°F (70°C) Nominally Rated, Upright Sprinklers | | | | | | Dry System, 280°F (140°C) Nominally Rated, Upright Sprinklers | | | | |
| | Quick Response | | | | | | Standard Response | | | Quick Response | | | | Standard Response | | Standard Response | | | | |
| | K11.2 (K160) | K14.0 (K200) | K16.8 (K240) | K22.4 (K320) | K25.2 (K360) | K25.2EC (K360EC) | K11.2 (K160) | K14.0 (K200) | K19.6 (K280) | K25.2 (K360) | K11.2 (K160) | K14.0 (K200) | K16.8 (K240) | K25.2EC (K360EC) | K11.2 (K160) | K16.8 (K240) | K25.2 (K360) | K11.2 (K160) | K16.8 (K240) | K25.2 (K360) |
| 10 (3.0) | 12 @ 10 (0.7) | 12 @ 7 (0.5) | 12 @ 7 (0.5) | 9 @ 20 (1.4) | 9 @ 20 (1.4) | 6 @ 20 (1.4) | 12 @ 10 (0.7) | 12 @ 7 (0.5) | 12 @ 16 (1.1) | 12 @ 7 (0.5) | 12 @ 10 (0.7) | 12 @ 7 (0.5) | 12 @ 7 (0.5) | 6 @ 20 (1.4) | 12 @ 10 (0.7) | 12 @ 7 (0.5) | 12 @ 7 (0.5) | 16 @ 10 (0.7) | 16 @ 7 (0.5) | 16 @ 7 (0.5) |
| 20 (6.0) | 12 @ 40 (2.8) | 12 @ 18 (1.2) | 12 @ 13 (0.9) | 9 @ 20 (1.4) | 9 @ 20 (1.4) | 6 @ 20 (1.4) | 12 @ 40 (2.8) | 12 @ 18 (1.2) | 12 @ 16 (1.1) | 12 @ 7 (0.5) | 12 @ 40 (2.8) | 12 @ 26 (1.8) | 12 @ 18 (1.2) | 6 @ 20 (1.4) | 12 @ 40 (2.8) | 12 @ 18 (1.2) | 12 @ 8 (0.6) | 16 @ 40 (2.8) | 16 @ 18 (1.2) | 16 @ 8 (0.6) |
| 25 (7.5) | 12 @ 50 (3.5) | 9 @ 50 (3.5) | 9 @ 35 (2.4) | 9 @ 20 (1.4) | 9 @ 20 (1.4) | 6 @ 20 (1.4) | 12 @ 50 (3.5) | 12 @ 32 (2.2) | 12 @ 16 (1.1) | 12 @ 10 (0.7) | 12 @ 50 (3.5) | 12 @ 32 (2.2) | 12 @ 22 (1.5) | 6 @ 20 (1.4) | 12 @ 50 (3.5) | 12 @ 22 (1.5) | 12 @ 10 (0.7) | 20 @ 50 (3.5) | 20 @ 22 (1.5) | 20 @ 10 (0.7) |
| 30 (9.0) | 25 @ 50 (3.5) | 12 @ 50 (3.5) | 12 @ 35 (2.4) | 12 @ 25 (1.7) | 12 @ 20 (1.4) | 12 @ 38 (2.6) | 25 @ 50 (3.5) | 25 @ 32 (2.2) | 25 @ 20 (1.4) | 25 @ 10 (0.7) | 25 @ 50 (3.5) | 12 @ 50 (3.5) | 12 @ 35 (2.4) | 12 @ 38 (2.6) | 25 @ 50 (3.5) | 25 @ 22 (1.5) | 25 @ 10 (0.7) | 30 @ 50 (3.5) | 30 @ 22 (1.5) | 30 @ 10 (0.7) |
| 35 (10.5) | | | | 12 @ 63 (4.3) | 12 @ 50 (3.5) | | | | | | | | | | | | | | | |
| 40 (12.0) | | | | 12 @ 75 (5.2) | 12 @ 60 (4.1) | | | | | | | | | | | | | | | |

Table 5. Ceiling-Level Protection Guidelines for Uncartoned Unexpanded Plastic Commodities in a Solid-Piled, Palletized, Shelf, or Bin-Box Storage Arrangement

| Max. Ceiling Height, ft (m) | Protection of Uncartoned Unexpanded Plastic Commodities in Solid-Piled, Palletized, Shelf, and Bin-Box Arrangements; No. of AS @ psi (bar) | | | | | | | | | | | | | | | | | | | |
|-----------------------------|--|---------------|---------------|-------------------|---------------|------------------|--|---------------|---------------|-------------------|---------------|---------------|---|------------------|---------------|---------------|---------------|---------------|---------------|---------------|
| | Wet System, 160°F (70°C) Nominally Rated, Pendent Sprinklers | | | | | | Wet System, 160°F (70°C) Nominally Rated, Upright Sprinklers | | | | | | Dry System, 280°F (140°C) Nominally Rated, Upright Sprinklers | | | | | | | |
| | Quick Response | | | Standard Response | | | Quick Response | | | Standard Response | | | Standard Response | | | | | | | |
| | K11.2 (K160) | K14.0 (K200) | K16.8 (K240) | K22.4 (K320) | K25.2 (K360) | K25.2EC (K360EC) | K11.2 (K160) | K14.0 (K200) | K19.6 (K280) | K25.2 (K360) | K11.2 (K160) | K14.0 (K200) | K16.8 (K240) | K25.2EC (K360EC) | K11.2 (K160) | K16.8 (K240) | K25.2 (K360) | K11.2 (K160) | K16.8 (K240) | K25.2 (K360) |
| 10 (3.0) | 12 @ 10 (0.7) | 12 @ 7 (0.5) | 12 @ 7 (0.5) | 9 @ 20 (1.4) | 9 @ 20 (1.4) | 6 @ 20 (1.4) | 12 @ 10 (0.7) | 12 @ 7 (0.5) | 12 @ 16 (1.1) | 12 @ 7 (0.5) | 12 @ 10 (0.7) | 12 @ 7 (0.5) | 12 @ 7 (0.5) | 6 @ 20 (1.4) | 12 @ 10 (0.7) | 12 @ 7 (0.5) | 12 @ 7 (0.5) | 16 @ 10 (0.7) | 16 @ 7 (0.5) | 16 @ 7 (0.5) |
| 20 (6.0) | 12 @ 40 (2.8) | 12 @ 26 (1.8) | 12 @ 18 (1.2) | 9 @ 20 (1.4) | 9 @ 20 (1.4) | 6 @ 30 (2.1) | 12 @ 40 (2.8) | 12 @ 26 (1.8) | 12 @ 16 (1.1) | 12 @ 8 (0.6) | 12 @ 40 (2.8) | 12 @ 26 (1.8) | 12 @ 18 (1.2) | 6 @ 30 (2.1) | 12 @ 40 (2.8) | 12 @ 18 (1.2) | 12 @ 8 (0.6) | 16 @ 40 (2.8) | 16 @ 18 (1.2) | 16 @ 8 (0.6) |
| 25 (7.5) | 12 @ 50 (3.5) | 9 @ 50 (3.5) | 9 @ 35 (2.4) | 9 @ 20 (1.4) | 9 @ 20 (1.4) | 6 @ 38 (2.6) | 12 @ 50 (3.5) | 12 @ 32 (2.2) | 12 @ 16 (1.1) | 12 @ 10 (0.7) | 12 @ 50 (3.5) | 12 @ 32 (2.2) | 12 @ 22 (1.5) | 6 @ 38 (2.6) | 12 @ 50 (3.5) | 12 @ 22 (1.5) | 12 @ 10 (0.7) | 20 @ 50 (3.5) | 20 @ 22 (1.5) | 20 @ 10 (0.7) |
| 30 (9.0) | 25 @ 50 (3.5) | 9 @ 100 (6.9) | 9 @ 70 (4.8) | 9 @ 50 (3.5) | 9 @ 40 (2.8) | 12 @ 38 (2.6) | 25 @ 50 (3.5) | 25 @ 32 (2.2) | 25 @ 16 (1.1) | 25 @ 10 (0.7) | 25 @ 50 (3.5) | 25 @ 32 (2.2) | 25 @ 22 (1.5) | 12 @ 38 (2.6) | 25 @ 50 (3.5) | 25 @ 22 (1.5) | 25 @ 10 (0.7) | 30 @ 50 (3.5) | 30 @ 22 (1.5) | 30 @ 10 (0.7) |
| 35 (10.5) | | | | 12 @ 63 (4.3) | 12 @ 50 (3.5) | | | | | | | | | | | | | | | |
| 40 (12.0) | | | | 12 @ 75 (5.2) | 12 @ 60 (4.1) | | | | | | | | | | | | | | | |

Table 6. Ceiling-Level Protection Guidelines for Uncartoned Expanded Plastic Commodities in a Solid-Piled, Palletized, Shelf or Bin-Box Storage Arrangement

| Max. Ceiling Height, ft (m) | Protection of Uncartoned Expanded Plastic Commodities in Solid-Piled, Palletized, Shelf and Bin-Box Arrangements; No. of AS @ psi (bar) | | | | | | | | | | | | | | | | | | | |
|-----------------------------|---|---------------|---------------|-------------------|---------------|------------------|--|---------------|---------------|-------------------|---------------|---------------|---|------------------|---------------|---------------|---------------|---------------|---------------|---------------|
| | Wet System, 160°F (70°C) Nominally Rated, Pendent Sprinklers | | | | | | Wet System, 160°F (70°C) Nominally Rated, Upright Sprinklers | | | | | | Dry System, 280°F (140°C) Nominally Rated, Upright Sprinklers | | | | | | | |
| | Quick Response | | | Standard Response | | | Quick Response | | | Standard Response | | | Standard Response | | | | | | | |
| | K11.2 (K160) | K14.0 (K200) | K16.8 (K240) | K22.4 (K320) | K25.2 (K360) | K25.2EC (K360EC) | K11.2 (K160) | K14.0 (K200) | K19.6 (K280) | K25.2 (K360) | K11.2 (K160) | K14.0 (K200) | K16.8 (K240) | K25.2EC (K360EC) | K11.2 (K160) | K16.8 (K240) | K25.2 (K360) | K11.2 (K160) | K16.8 (K240) | K25.2 (K360) |
| 10 (3.0) | 12 @ 10 (0.7) | 12 @ 7 (0.5) | 12 @ 7 (0.5) | 9 @ 20 (1.4) | 9 @ 20 (1.4) | 6 @ 20 (1.4) | 12 @ 10 (0.7) | 12 @ 7 (0.5) | 12 @ 16 (1.1) | 12 @ 7 (0.5) | 12 @ 10 (0.7) | 12 @ 7 (0.5) | 12 @ 7 (0.5) | 6 @ 20 (1.4) | 12 @ 10 (0.7) | 12 @ 7 (0.5) | 12 @ 7 (0.5) | 20 @ 10 (0.7) | 20 @ 7 (0.5) | 20 @ 7 (0.5) |
| 20 (6.0) | 12 @ 40 (2.8) | 12 @ 26 (1.8) | 12 @ 18 (1.2) | 9 @ 20 (1.4) | 9 @ 20 (1.4) | 6 @ 30 (2.1) | 12 @ 40 (2.8) | 12 @ 26 (1.8) | 12 @ 16 (1.1) | 12 @ 8 (0.6) | 12 @ 40 (2.8) | 12 @ 26 (1.8) | 12 @ 18 (1.2) | 6 @ 30 (2.1) | 12 @ 40 (2.8) | 12 @ 18 (1.2) | 12 @ 8 (0.6) | 20 @ 40 (2.8) | 20 @ 18 (1.2) | 20 @ 8 (0.6) |
| 25 (7.5) | 12 @ 50 (3.5) | 9 @ 75 (5.2) | 9 @ 52 (3.6) | 9 @ 32 (2.2) | 9 @ 25 (1.7) | 6 @ 38 (2.6) | 12 @ 50 (3.5) | 12 @ 32 (2.2) | 12 @ 16 (1.1) | 12 @ 10 (0.7) | 12 @ 50 (3.5) | 12 @ 32 (2.2) | 12 @ 22 (1.5) | 6 @ 38 (2.6) | 12 @ 50 (3.5) | 12 @ 22 (1.5) | 12 @ 10 (0.7) | 20 @ 50 (3.5) | 20 @ 22 (1.5) | 20 @ 10 (0.7) |
| 30 (9.0) | | 9 @ 100 (6.9) | 9 @ 70 (4.8) | 9 @ 50 (3.5) | 9 @ 40 (2.8) | | | | | | | | | | | | | | | |
| 40 (12.0) | | | | | 20 @ 75 (5.2) | | | | | | | | | | | | | | | |

Table 7. Ceiling-Level Protection Guidelines for Class 1, 2 and 3 Commodities in Open-Frame Rack Storage Arrangements

| Max. Ceiling Height, ft (m) | Wet System, 160°F (70°C) Nominally Rated, Pendent Sprinklers | | | | | | | | | | Wet System, 160°F (70°C) Nominally Rated, Upright Sprinklers | | | | | | Dry System, 280°F (140°C) Nominally Rated, Upright Sprinklers | | | |
|-----------------------------|--|---------------|---------------|---------------|---------------|---------------------------|---------------|---------------|---------------|--------------|--|---------------|---------------|------------------|-------------------|---------------|---|---------------------|---------------|---------------|
| | Quick Response | | | | | Standard Response | | | | | Quick Response | | | | Standard Response | | Standard Response | | | |
| | K11.2 (K160) | K14.0 (K200) | K16.8 (K240) | K22.4 (K320) | K25.2 (K360) | K25.2EC (K360EC) | K11.2 (K160) | K14.0 (K200) | K19.6 (K280) | K25.2 (K360) | K11.2 (K160) | K14.0 (K200) | K16.8 (K240) | K25.2EC (K360EC) | K11.2 (K160) | K16.8 (K240) | K25.2 (K360) | K11.2 (K160) | K16.8 (K240) | K25.2 (K360) |
| 10 (3.0) | 12 @ 7 (0.5) | 9 @ 7 (0.5) | 9 @ 7 (0.5) | 9 @ 20 (1.4) | 9 @ 20 (1.4) | 6 @ 20 (1.4) | 12 @ 7 (0.5) | 9 @ 7 (0.5) | 9 @ 16 (1.1) | 9 @ 7 (0.5) | 12 @ 7 (0.5) | 9 @ 7 (0.5) | 9 @ 7 (0.5) | 6 @ 20 (1.4) | 12 @ 7 (0.5) | 9 @ 7 (0.5) | 9 @ 7 (0.5) | 16 @ 7 (0.5) | 16 @ 7 (0.5) | 16 @ 7 (0.5) |
| 20 (6.0) | 12 @ 10 (0.7) | 12 @ 7 (0.5) | 12 @ 7 (0.5) | 9 @ 20 (1.4) | 9 @ 20 (1.4) | 6 @ 20 (1.4) | 12 @ 10 (0.7) | 12 @ 7 (0.5) | 9 @ 16 (1.1) | 9 @ 10 (0.7) | 12 @ 10 (0.7) | 12 @ 7 (0.5) | 12 @ 7 (0.5) | 6 @ 20 (1.4) | 12 @ 10 (0.7) | 12 @ 7 (0.5) | 12 @ 7 (0.5) | 16 @ 10 (0.7) | 16 @ 7 (0.5) | 16 @ 7 (0.5) |
| 25 (7.5) | 15 @ 16 (1.1) | 12 @ 16 (1.1) | 12 @ 11 (0.8) | 9 @ 20 (1.4) | 9 @ 20 (1.4) | 6 @ 22 (1.5) | 15 @ 16 (1.1) | 15 @ 10 (0.7) | 9 @ 16 (1.1) | 9 @ 10 (0.7) | 15 @ 16 (1.1) | 12 @ 16 (1.1) | 12 @ 11 (0.8) | 6 @ 22 (1.5) | 15 @ 16 (1.1) | 15 @ 7 (0.5) | 10 @ 20 (1.4) | 20 @ 16 (1.1) | 20 @ 7 (0.5) | 20 @ 7 (0.5) |
| 30 (9.0) | 18 @ 50 (3.5) | 12 @ 50 (3.5) | 12 @ 35 (2.4) | 9 @ 20 (1.4) | 9 @ 20 (1.4) | 6 @ 30 (2.1) | 18 @ 50 (3.5) | 18 @ 32 (2.2) | 9 @ 16 (1.1) | 9 @ 10 (0.7) | 18 @ 50 (3.5) | 12 @ 50 (3.5) | 12 @ 35 (2.4) | 6 @ 30 (2.1) | 18 @ 50 (3.5) | 18 @ 22 (1.5) | 12 @ 20 (1.4) | 25 @ 50 (3.5) | 25 @ 22 (1.5) | 25 @ 10 (0.7) |
| 35 (10.5) | | 12 @ 75 (5.2) | 12 @ 52 (3.6) | 12 @ 29 (2.0) | 12 @ 23 (1.6) | 6 @ 60 (4.1) ^a | | | 15 @ 25 (1.7) | 9 @ 30 (2.1) | | | | 8 @ 40 (2.8) | | | | See Section 2.3.6.1 | | |
| 40 (12.0) | | 12 @ 75 (5.2) | 12 @ 52 (3.6) | 9 @ 50 (3.5) | 9 @ 40 (2.8) | | | | 9 @ 30 (2.1) | | | | | | | | | | | |

^a An acceptable alternative design is 8 @ 40 (2.8) when a 12 ft (3.6 m) maximum linear spacing is used

Table 8. Ceiling-Level Protection Guidelines for Class 4 and Cartoned Unexpanded Plastic Commodities in Open-Frame Rack Storage Arrangements

| Max. Ceiling Height, ft (m) | Wet System, 160°F (70°C) Nominally Rated, Pendent Sprinklers | | | | | | | | | | | Wet System, 160°F (70°C) Nominally Rated, Upright Sprinklers | | | | Dry System, 280°F (140°C) Nominally Rated, Upright Sprinklers | | | | |
|-----------------------------|--|---------------|---------------|---------------|---------------|---------------------------|-------------------|---------------|---------------|---------------|---------------|--|---------------|------------------|---------------|---|---------------|---------------|---------------|---------------|
| | Quick Response | | | | | | Standard Response | | | | | Quick Response | | | | Standard Response | | | | |
| | K11.2 (K160) | K14.0 (K200) | K16.8 (K240) | K22.4 (K320) | K25.2 (K360) | K25.2EC (K360EC) | K11.2 (K160) | K14.0 (K200) | K19.6 (K280) | K25.2 (K360) | K11.2 (K160) | K14.0 (K200) | K16.8 (K240) | K25.2EC (K360EC) | K11.2 (K160) | K16.8 (K240) | K25.2 (K360) | K11.2 (K160) | K16.8 (K240) | K25.2 (K360) |
| 10 (3.0) | 12 @ 7 (0.5) | 9 @ 7 (0.5) | 9 @ 7 (0.5) | 9 @ 20 (1.4) | 9 @ 20 (1.4) | 6 @ 20 (1.4) | 12 @ 7 (0.5) | 9 @ 7 (0.5) | 9 @ 16 (1.1) | 9 @ 7 (0.5) | 12 @ 7 (0.5) | 9 @ 7 (0.5) | 9 @ 7 (0.5) | 6 @ 20 (1.4) | 12 @ 7 (0.5) | 9 @ 7 (0.5) | 9 @ 7 (0.5) | 16 @ 7 (0.5) | 16 @ 7 (0.5) | 16 @ 7 (0.5) |
| 15 (4.5) | 15 @ 16 (1.1) | 12 @ 16 (1.1) | 12 @ 11 (0.8) | 9 @ 20 (1.4) | 9 @ 20 (1.4) | 6 @ 20 (1.4) | 15 @ 16 (1.1) | 12 @ 16 (1.1) | 9 @ 16 (1.1) | 10 @ 7 (0.5) | 15 @ 16 (1.1) | 12 @ 16 (1.1) | 12 @ 11 (0.8) | 6 @ 20 (1.4) | 15 @ 16 (1.1) | 12 @ 11 (0.8) | 10 @ 7 (0.5) | 20 @ 16 (1.1) | 20 @ 7 (0.5) | 20 @ 7 (0.5) |
| 20 (6.0) | 12 @ 30 (2.1) | 12 @ 18 (1.2) | 12 @ 13 (0.9) | 9 @ 20 (1.4) | 9 @ 20 (1.4) | 6 @ 22 (1.5) | 12 @ 30 (2.1) | 12 @ 18 (1.2) | 9 @ 16 (1.1) | 12 @ 7 (0.5) | 12 @ 30 (2.1) | 12 @ 18 (1.2) | 12 @ 13 (0.9) | 6 @ 22 (1.5) | 12 @ 30 (2.1) | 12 @ 13 (0.9) | 12 @ 7 (0.5) | 20 @ 30 (2.1) | 20 @ 13 (0.9) | 20 @ 7 (0.5) |
| 25 (7.5) | 15 @ 65 (4.5) | 9 @ 35 (2.4) | 9 @ 24 (1.7) | 9 @ 20 (1.4) | 9 @ 20 (1.4) | 6 @ 22 (1.5) | 15 @ 65 (4.5) | 15 @ 42 (2.9) | 9 @ 16 (1.1) | 12 @ 10 (0.7) | 15 @ 65 (4.5) | 12 @ 50 (3.5) | 12 @ 35 (2.4) | 6 @ 22 (1.5) | 15 @ 65 (4.5) | 15 @ 29 (2.0) | 12 @ 20 (1.4) | 20 @ 65 (4.5) | 20 @ 29 (2.0) | 20 @ 13 (0.9) |
| 30 (9.0) | | 12 @ 50 (3.5) | 12 @ 35 (2.4) | 9 @ 20 (1.4) | 9 @ 20 (1.4) | 6 @ 30 (2.1) | | | 9 @ 16 (1.1) | 12 @ 15 (1.0) | | | | 6 @ 30 (2.1) | | | 12 @ 20 (1.4) | | | 30 @ 20 (1.4) |
| 35 (10.5) | | 12 @ 75 (5.2) | 12 @ 52 (3.6) | 12 @ 29 (2.0) | 12 @ 23 (1.6) | 6 @ 60 (4.1) ^a | | | 15 @ 25 (1.7) | 9 @ 30 (2.1) | | | | 8 @ 40 (2.8) | | | | | | |
| 40 (12.0) | | 12 @ 75 (5.2) | 12 @ 52 (3.6) | 9 @ 50 (3.5) | 9 @ 40 (2.8) | | | | | 9 @ 30 (2.1) | | | | | | | | | | |

^a An acceptable alternative design is 8 @ 40 (2.8) when a 12 ft (3.6 m) maximum linear spacing is used

Table 9. Ceiling-Level Protection Guidelines for Cartoned Expanded Plastic Commodities in Open-Frame Rack Storage Arrangements

| Max. Ceiling Height, ft (m) | Wet System, 160°F (70°C) Nominally Rated, Pendent Sprinklers | | | | | | | | | | Wet System, 160°F (70°C) Nominally Rated, Upright Sprinklers | | | | | Dry System, 280°F (140°C) Nominally Rated, Upright Sprinklers | | | | |
|-----------------------------|--|---------------|---------------|---------------|---------------|------------------|-------------------|---------------|---------------|---------------|--|---------------|---------------|------------------|-------------------|---|---------------|-------------------|---------------|---------------|
| | Quick Response | | | | | | Standard Response | | | | Quick Response | | | | Standard Response | | | Standard Response | | |
| | K11.2 (K160) | K14.0 (K200) | K16.8 (K240) | K22.4 (K320) | K25.2 (K360) | K25.2EC (K360EC) | K11.2 (K160) | K14.0 (K200) | K19.6 (K280) | K25.2 (K360) | K11.2 (K160) | K14.0 (K200) | K16.8 (K240) | K25.2EC (K360EC) | K11.2 (K160) | K16.8 (K240) | K25.2 (K360) | K11.2 (K160) | K16.8 (K240) | K25.2 (K360) |
| 10 (3.0) | 15 @ 10 (0.7) | 15 @ 7 (0.5) | 15 @ 7 (0.5) | 9 @ 20 (1.4) | 9 @ 20 (1.4) | 6 @ 20 (1.4) | 15 @ 10 (0.7) | 15 @ 7 (0.5) | 12 @ 16 (1.1) | 15 @ 7 (0.5) | 15 @ 10 (0.7) | 15 @ 7 (0.5) | 15 @ 7 (0.5) | 6 @ 20 (1.4) | 15 @ 10 (0.7) | 15 @ 7 (0.5) | 15 @ 7 (0.5) | 20 @ 10 (0.7) | 20 @ 7 (0.5) | 20 @ 7 (0.5) |
| 20 (6.0) | 18 @ 28 (1.9) | 12 @ 18 (1.2) | 12 @ 13 (0.9) | 9 @ 20 (1.4) | 9 @ 20 (1.4) | 9 @ 21 (1.4) | 18 @ 28 (1.9) | 15 @ 18 (1.2) | 15 @ 16 (1.1) | 15 @ 7 (0.5) | 15 @ 50 (3.5) | 12 @ 50 (3.5) | 12 @ 35 (2.4) | 8 @ 35 (2.4) | 15 @ 50 (3.5) | 15 @ 22 (1.5) | 15 @ 10 (0.7) | 20 @ 50 (3.5) | 20 @ 22 (1.5) | 20 @ 10 (0.7) |
| 25 (7.5) | | 12 @ 35 (2.4) | 12 @ 24 (1.7) | 10 @ 20 (1.4) | 9 @ 20 (1.4) | 8 @ 60 (4.1) | | 15 @ 50 (3.5) | 15 @ 25 (1.7) | 15 @ 15 (1.0) | | 12 @ 50 (3.5) | 12 @ 35 (2.4) | | | | | | | |
| 30 (9.0) | | 12 @ 50 (3.5) | 12 @ 35 (2.4) | 12 @ 25 (1.7) | 12 @ 20 (1.4) | | | | | | | | | | | | | | | |
| 40 (12.0) | | | | 12 @ 75 (5.2) | 12 @ 60 (4.1) | | | | | | | | | | | | | | | |

Table 10. Ceiling-Level Protection Guidelines for Uncartoned Unexpanded Plastic Commodities in Open-Frame Rack Storage Arrangements

| Max. Ceiling Height, ft (m) | Wet System, 160°F (70°C) Nominally Rated, Pendent Sprinklers | | | | | | | | | | Wet System, 160°F (70°C) Nominally Rated, Upright Sprinklers | | | | | Dry System, 280°F (140°C) Nominally Rated, Upright Sprinklers | | | | |
|-----------------------------|--|---------------|---------------|---------------|---------------|------------------|-------------------|---------------|---------------|---------------|--|---------------|---------------|------------------|-------------------|---|---------------|-------------------|---------------|---------------|
| | Quick Response | | | | | | Standard Response | | | | Quick Response | | | | Standard Response | | | Standard Response | | |
| | K11.2 (K160) | K14.0 (K200) | K16.8 (K240) | K22.4 (K320) | K25.2 (K360) | K25.2EC (K360EC) | K11.2 (K160) | K14.0 (K200) | K19.6 (K280) | K25.2 (K360) | K11.2 (K160) | K14.0 (K200) | K16.8 (K240) | K25.2EC (K360EC) | K11.2 (K160) | K16.8 (K240) | K25.2 (K360) | K11.2 (K160) | K16.8 (K240) | K25.2 (K360) |
| 10 (3.0) | 15 @ 10 (0.7) | 15 @ 7 (0.5) | 15 @ 7 (0.5) | 9 @ 20 (1.4) | 9 @ 20 (1.4) | 6 @ 20 (1.4) | 15 @ 10 (0.7) | 15 @ 7 (0.5) | 12 @ 16 (1.1) | 15 @ 7 (0.5) | 15 @ 10 (0.7) | 15 @ 7 (0.5) | 15 @ 7 (0.5) | 6 @ 20 (1.4) | 15 @ 10 (0.7) | 15 @ 7 (0.5) | 15 @ 7 (0.5) | 20 @ 10 (0.7) | 20 @ 7 (0.5) | 20 @ 7 (0.5) |
| 15 (4.5) | 15 @ 50 (3.5) | 12 @ 32 (2.2) | 12 @ 22 (1.5) | 9 @ 25 (1.7) | 9 @ 20 (1.4) | 6 @ 60 (4.1) | 15 @ 50 (3.5) | 12 @ 50 (3.5) | 12 @ 25 (1.7) | 12 @ 15 (1.0) | 15 @ 50 (3.5) | 15 @ 32 (2.2) | 15 @ 22 (1.5) | 8 @ 35 (2.4) | 15 @ 50 (3.5) | 15 @ 22 (1.5) | 15 @ 10 (0.7) | 20 @ 50 (3.5) | 20 @ 22 (1.5) | 20 @ 10 (0.7) |
| 20 (6.0) | | 9 @ 50 (3.5) | 9 @ 35 (2.4) | 9 @ 25 (1.7) | 9 @ 20 (1.4) | 6 @ 60 (4.1) | | 12 @ 50 (3.5) | 12 @ 25 (1.7) | 12 @ 15 (1.0) | | | | | | | | | | |
| 25 (7.5) | | 10 @ 50 (3.5) | 10 @ 35 (2.4) | 10 @ 25 (1.7) | 10 @ 20 (1.4) | | | | | | | | | | | | | | | |
| 30 (9.0) | | 15 @ 50 (3.5) | 15 @ 35 (2.4) | 10 @ 50 (3.5) | 10 @ 40 (2.8) | | | | | | | | | | | | | | | |
| 40 (12.0) | | | | 12 @ 75 (5.2) | 12 @ 60 (4.1) | | | | | | | | | | | | | | | |

Table 11. Ceiling-Level Protection Guidelines for Uncartoned Expanded Plastic Commodities in Open-Frame Rack Storage Arrangements

| Max. Ceiling Height, ft (m) | Wet System, 160°F (70°C) Nominally Rated, Pendent Sprinklers | | | | | | | | | | | Wet System, 160°F (70°C) Nominally Rated, Upright Sprinklers | | | | Dry System, 280°F (140°C) Nominally Rated, Upright Sprinklers | | | | |
|-----------------------------|--|----------------|---------------|---------------|---------------|------------------|-------------------|---------------|---------------|---------------|---------------|--|---------------|------------------|---------------|---|---------------|---------------|---------------|---------------|
| | Quick Response | | | | | | Standard Response | | | | | Quick Response | | | | Standard Response | | | | |
| | K11.2 (K160) | K14.0 (K200) | K16.8 (K240) | K22.4 (K320) | K25.2 (K360) | K25.2EC (K360EC) | K11.2 (K160) | K14.0 (K200) | K19.6 (K280) | K25.2 (K360) | K11.2 (K160) | K14.0 (K200) | K16.8 (K240) | K25.2EC (K360EC) | K11.2 (K160) | K16.8 (K240) | K25.2 (K360) | K11.2 (K160) | K16.8 (K240) | K25.2 (K360) |
| 10 (3.0) | 15 @ 10 (0.7) | 15 @ 7 (0.5) | 15 @ 7 (0.5) | 9 @ 20 (1.4) | 9 @ 20 (1.4) | 6 @ 20 (1.4) | 15 @ 10 (0.7) | 15 @ 7 (0.5) | 12 @ 16 (1.1) | 15 @ 7 (0.5) | 15 @ 10 (0.7) | 15 @ 7 (0.5) | 15 @ 7 (0.5) | 6 @ 20 (1.4) | 15 @ 10 (0.7) | 15 @ 7 (0.5) | 15 @ 7 (0.5) | 25 @ 10 (0.7) | 25 @ 7 (0.5) | 25 @ 7 (0.5) |
| 15 (4.5) | 15 @ 50 (3.5) | 12 @ 32 (2.2) | 12 @ 22 (1.5) | 9 @ 25 (1.7) | 9 @ 20 (1.4) | 8 @ 35 (2.4) | 15 @ 50 (3.5) | 15 @ 32 (2.2) | 15 @ 16 (1.1) | 15 @ 10 (0.7) | 15 @ 50 (3.5) | 15 @ 32 (2.2) | 15 @ 22 (1.5) | 8 @ 35 (2.4) | 15 @ 50 (3.5) | 15 @ 22 (1.5) | 15 @ 10 (0.7) | 25 @ 50 (3.5) | 25 @ 22 (1.5) | 25 @ 10 (0.7) |
| 25 (7.5) | | 12 @ 75 (5.2) | 12 @ 52 (3.6) | 9 @ 32 (2.2) | 9 @ 25 (1.7) | | | | | | | | | | | | | | | |
| 30 (9.0) | | 12 @ 100 (6.9) | 12 @ 70 (4.8) | 12 @ 50 (3.5) | 12 @ 40 (2.8) | | | | | | | | | | | | | | | |
| 40 (12.0) | | | | | 20 @ 75 (5.2) | | | | | | | | | | | | | | | |

2.3.3.7.3 Ceiling Heights in Excess of Those Indicated in Protection Tables for Ceiling-Level Storage Sprinklers

When ceiling heights at storage facilities are in excess of those indicated in the applicable protection table from Section 2.3.3.7.2 or Section 2.3.6, see the guidelines in Section 2.3.3.7.3.1 for storage arrangements involving racks, or Section 2.3.3.7.3.2 for solid-piled, palletized, shelf, and bin-box storage arrangements.

2.3.3.7.3.1 Ceiling Heights in Excess of Those Indicated in Protection Tables for Ceiling-Level Storage Sprinklers Protecting Rack Storage

When ceiling heights at storage facilities are in excess of what is indicated in the applicable protection table in Section 2.3.3.7.2 or Section 2.3.6 for the commodity being protected, a ceiling-only sprinkler system is not an option.

Implement one of the two options listed below when ceiling-only options are not available.

2.3.3.7.3.1.1. Option 1: Installation of a False Ceiling

Install a noncombustible false ceiling directly over and at least 15 ft (4.5 m) beyond the storage area. Design the false ceiling in accordance with Data Sheet 1-12, *Ceilings and Concealed Spaces*. Provide sprinklers under the false ceiling and design them based on the guidelines indicated in the applicable protection table for the height above the floor over which the false ceiling has been installed. If, however, in-racks are still needed, even in the presence of a false ceiling, design the sprinklers under the false ceiling in accordance with Table 13 as described in Section 2.3.4.8.2.

2.3.3.7.3.1.2. Option 2: Installation of In-Rack Sprinklers

Follow the guidelines in Section 2.3.4.6 to determine the acceptable horizontal layout of the in-rack sprinklers, and Section 2.3.4.7 for the vertical increments in which the in-rack sprinklers can be installed.

If there is more than 20 ft (6.0 m) of vertical clearance between the top of storage and the ceiling above, supplement the existing in-rack sprinkler arrangement obtained from Sections 2.3.4.6 and 2.3.4.7 by installing in-rack sprinklers at the top tier level of the storage rack. Use an in-rack arrangement in accordance with Figures 11, 13, and 14, depending on the rack type. If a horizontal barrier is provided above this top level of in-rack sprinklers, Figure 12 can be used as an alternative for double-row racks, and Figure 10 can be used as an alternative for multiple-row racks. Design the ceiling-level sprinklers in accordance with Table 13 (Section 2.3.4.8.2) based on an IRAS(E) in-rack sprinkler arrangement and ceiling clearance of 20 ft (6.0 m). Limit the storage on the top tier to a maximum of 5 ft (1.5 m).

2.3.3.7.3.2 Ceiling Heights in Excess of Those Indicated in Protection Tables for Ceiling-Level Storage Sprinklers Protecting Solid-Piled, Palletized, Shelf, or Bin-Box Storage Arrangements

When ceiling heights at storage facilities are in excess of what is indicated in the applicable protection table in Section 2.3.3.7.2 or Section 2.3.6 for the commodity being protected, a ceiling-only sprinkler system is not an option.

Implement one of the two options listed below when ceiling-only options are not available.

2.3.3.7.3.2.1 Option 1: Installation of a False Ceiling

Install a noncombustible false ceiling directly over and at least 15 ft (4.5 m) beyond the storage area. Design the false ceiling in accordance with Data Sheet 1-12, *Ceilings and Concealed Spaces*. Provide sprinklers under the false ceiling and design them based on the guidelines indicated in the applicable protection table for the height above the floor over which the false ceiling has been installed.

2.3.3.7.3.2.2 Option 2: Installation of In-Rack Sprinklers

If a false ceiling as indicated in Option 1 cannot be installed, the storage arrangement will need to be converted to a rack storage arrangement protected with in-rack sprinklers. Follow the guidelines in Section 2.3.3.7.3.1.2 for the installation of in-rack sprinklers within these storage racks.

2.3.4 In-Rack Sprinklers (IRAS)

2.3.4.1 General

Protection options for rack storage arrangements are based on ceiling-only sprinkler systems, or a combination of ceiling-level and in-rack sprinkler systems. When in-rack sprinklers are needed, they can be used in combination with any of the ceiling sprinklers listed in the protection tables indicated for rack storage.

2.3.4.1.1 When in-rack sprinklers are needed as a supplement to ceiling-level sprinklers, as outlined in Section 2.3.4.2, use FM Approved in-rack sprinklers listed in the *Approval Guide*, an online resource of FM Approvals, under the heading of Storage Sprinklers (In-Racks).

2.3.4.1.2 Use in-rack sprinklers equipped with water shields when 2 levels of in-rack sprinklers are indicated for the in-rack sprinkler system design.

2.3.4.1.3 The use of water shields for in-rack sprinklers as outlined in Section 2.3.4.1.2 can be avoided when in-rack sprinklers are installed in the presence of horizontal barriers or solid shelves that block water from discharging on the in-rack sprinklers.

2.3.4.1.4 If in-rack sprinklers are recommended in Section 2.3.4.2 for the rack storage arrangement and commodity hazard involved, use the following procedure to determine the recommended protection for both the ceiling and in-rack sprinkler systems:

1. Determine the available horizontal in-rack sprinkler arrangements per Section 2.3.4.6
2. Determine the available vertical increments between in-rack sprinkler levels per Section 2.3.4.7
3. Determine the in-rack sprinkler system design guidelines per Section 2.3.4.8.1
4. Determine the ceiling-level sprinkler system design guidelines when supplemented with in-rack sprinklers per Section 2.3.4.8.2
5. Determine the hydraulic design requirements for the ceiling sprinkler system from Table 1a in Section 2.3.3.7.2.6.
6. Determine the hose demand and duration for the combined ceiling-level and in-rack sprinkler system per Section 2.3.5.

2.3.4.1.5 See Section 2.3.6 for additional in-rack sprinkler protection recommendations that supplement the recommendations obtained from this section.

2.3.4.2 When In-Rack Sprinklers are Needed

The need for in-rack sprinklers is dependent on several parameters, including commodity hazard, ceiling height, available water supply, the presence of solid shelves or open-top containers, and the width and location of flue spaces. See Section 2.2.3.2 to determine if the storage racks meet the guidelines to be treated as open-frame racking. Use Figure 3 to determine when in-rack sprinklers are recommended.

2.3.4.3 K-Factors, Nominal Temperature Rating, and RTI Rating of In-Rack Storage Sprinklers

2.3.4.3.1 Use nominally rated 160°F (70°C) FM Approved in-rack sprinklers for all in-rack sprinkler installations.

2.3.4.3.2 Use in-rack sprinklers listed as quick-response.

2.3.4.3.3 Use a minimum K8.0 (K115) for in-rack sprinkler design flows greater than 30 gpm (115 L/min).

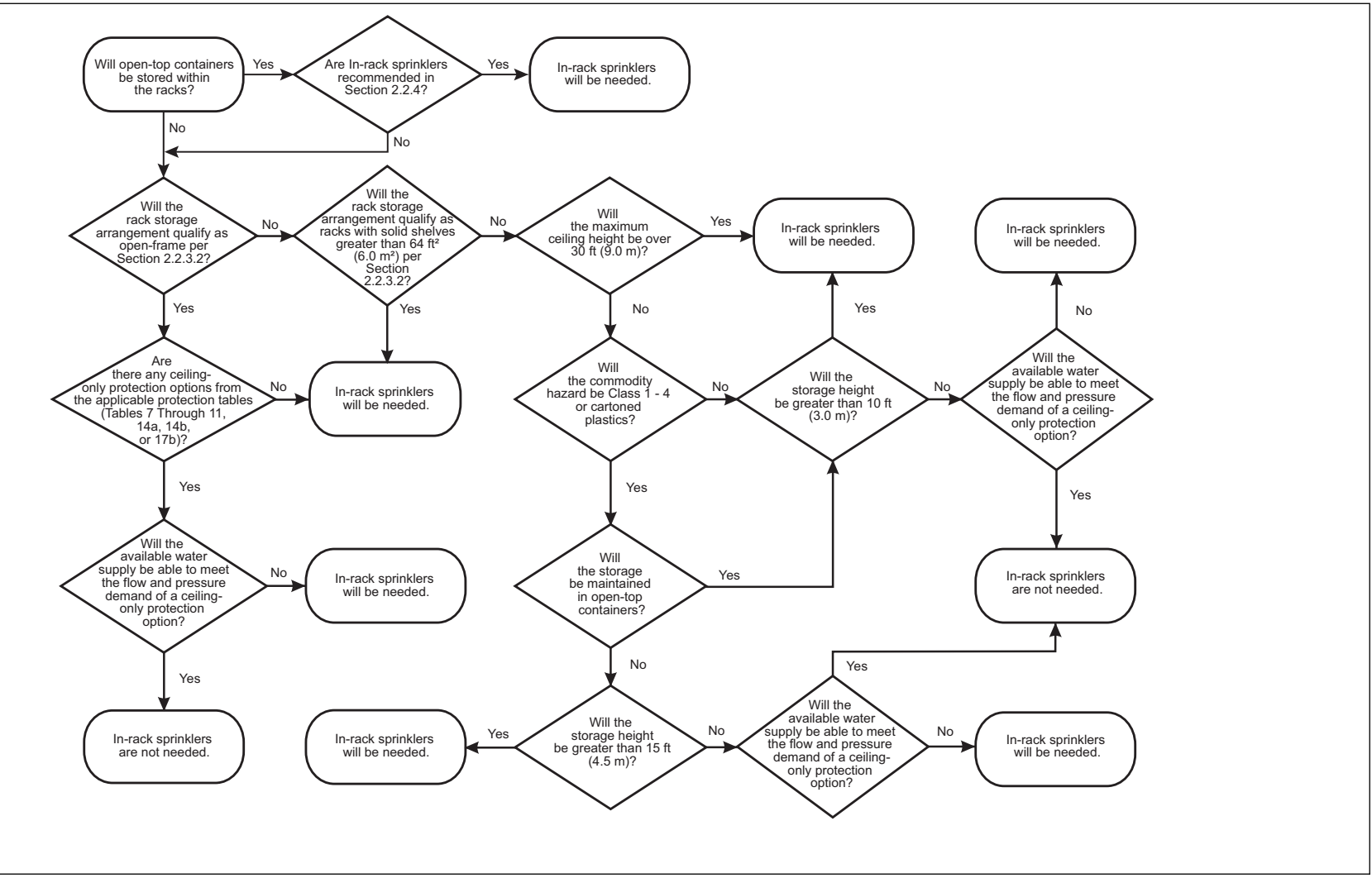

Fig. 3. Flowchart for evaluating the need for in-rack sprinklers

2.3.4.4 In-Rack Sprinkler System Types

In-rack sprinkler systems can be wet-pipe, dry-pipe, preaction, or refrigerated area. Note, however, that grid-type piping configurations are only recommended for wet-pipe sprinkler systems.

2.3.4.5 General Guidelines for Positioning of In-Rack Sprinklers

2.3.4.5.1 Locate all in-rack sprinklers within the rack storage structure.

2.3.4.5.2 Locate face sprinklers:

- A. Within the rack storage structure, and
- B. No more than 18 in. (450 mm) horizontally from the face of the storage rack.

2.3.4.5.3 In-rack sprinklers may be located outside the rack storage structure of a single-row rack having a maximum 4 ft (1.2 m) depth when:

- A. Face sprinklers are not required, and
- B. The rack is located no more than 12 in. (300 mm) horizontally from a wall, and
- C. The in-rack sprinklers are located no more than 6 in. (150 mm) horizontally away from the rack structure, and
- D. The in-rack sprinklers are located no more than 3 in. (75 mm) horizontally offset from the transverse flue space intersection they are intended to protect.

2.3.4.5.4 In-rack sprinklers may be located outside the rack storage structure of a single-row rack having a depth over 4 ft (1.2 m) when:

- A. Face sprinklers have been installed along the aisle face of the rack, and
- B. The rack is located no more than 12 in. (300 mm) horizontally from a wall, and
- C. The in-rack sprinklers are located no more than 6 in. (150 mm) horizontally away from the rack structure, and
- D. The in-rack sprinklers are located no more than 3 in. (75 mm) horizontally offset from the transverse flue space intersection they are intended to protect.

2.3.4.5.5 For in-rack sprinkler arrangements per Figures 9 and 12, or for in-rack sprinklers located outside the rack storage structure as outlined in Section 2.3.4.5.2, position the in-rack sprinklers such that:

- A. The in-rack sprinklers are not directly behind rack uprights, and
- B. The in-rack sprinklers are not more than 3 in. (75 mm) offset horizontally from the transverse flue space intersection they are intending to protect.

2.3.4.5.6 At each tier level where in-rack sprinklers are to be installed, position the in-rack sprinkler deflector a minimum of 6 in. (150 mm) vertically above the top of storage as well as at or just below the bottom of the rack's horizontal support member when it is under full load conditions. When a minimum 6 in. (150 mm) clearance cannot be provided between the in-rack sprinkler and the top of storage, additional in-rack sprinklers will be needed for single-row and double-row racks.

2.3.4.5.7 Face sprinklers are permitted to be installed above the bottom of the rack's horizontal support member that runs parallel to the storage aisle when the face sprinkler is offset a minimum of 3 in. (75 mm) from the horizontal support member.

2.3.4.5.8 Arrange sprinkler piping and in-rack sprinklers to avoid damage from material handling operations while also ensuring proper distribution from the in-rack sprinkler can be achieved. One potential way to protect the sprinkler piping and in-rack sprinklers from material handling damage in a double-row rack would be to install two horizontal support members at the face of the rack, but only a single horizontal support member in the longitudinal flue space. See Figure 4 for an example of this arrangement. Prior to installing in-rack sprinklers, check the proposed in-rack sprinkler locations to ensure both adequate protection against material handling operations damage and proper sprinkler discharge are provided.

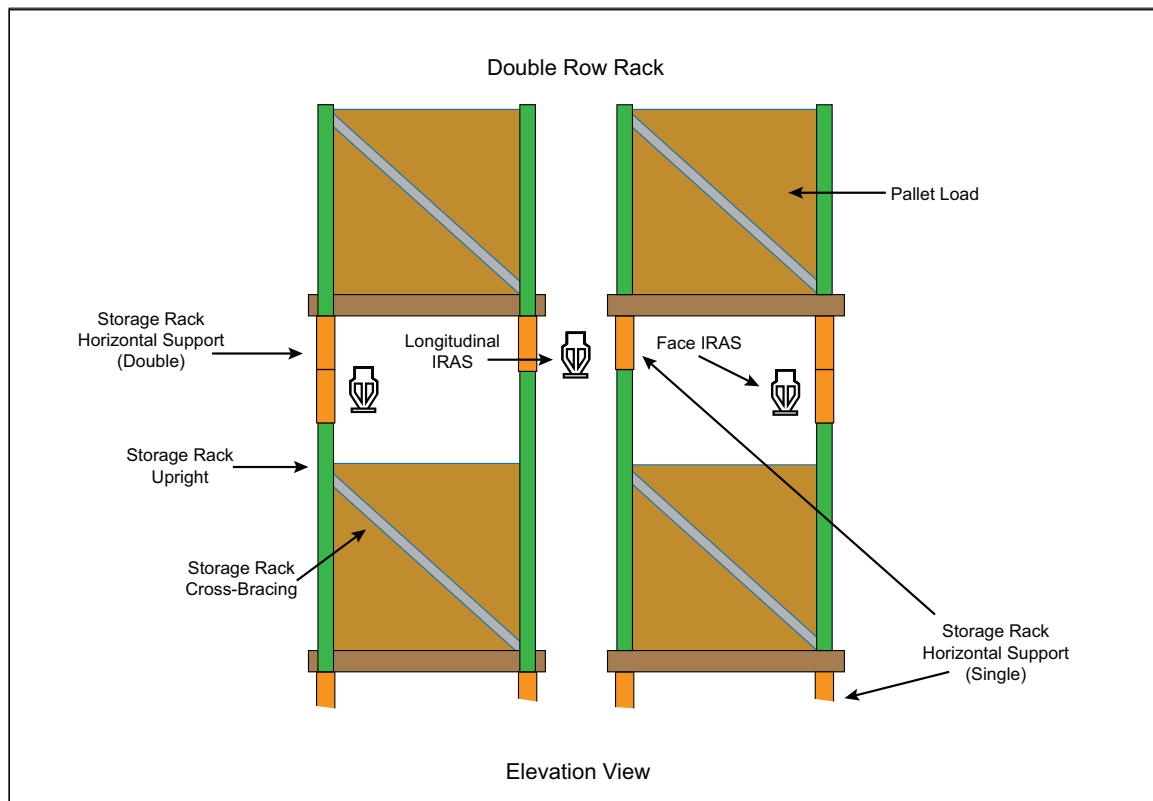

Fig. 4. Example of protecting in-rack sprinklers and sprinkler piping in a double-row rack

2.3.4.6 Horizontal Arrangements of In-Rack Sprinklers

2.3.4.6.1 General

2.3.4.6.1.1 There are two basic horizontal arrangements for in-rack sprinklers. They are as follows:

1. IRAS(EO), which represents in-rack sprinklers spaced horizontally at every other transverse flue space intersection between pallet loads
2. IRAS(E), which represents in-rack sprinklers spaced horizontally at every transverse flue space intersection between pallet loads

2.3.4.6.1.2 The type of horizontal in-rack sprinkler arrangement acceptable for installation will be dependent on:

1. the type of rack (single-row, double-row, or multiple-row) being protected,
2. the commodity being protected,
3. whether open-top containers are present,
4. the maximum ceiling height of the storage area,
5. whether a minimum 6 in. (150 mm) vertical clearance is provided between the top of storage and the in-rack sprinkler deflector, and
6. whether horizontal barriers are to be installed.

2.3.4.6.1.3 This data sheet provides figures showing plan views for both IRAS(EO) and IRAS(E) arrangements to assist in the proper location and spacing of the in-rack sprinklers. These figures use squares to represent nominal 20 ft² (2.0 m²) pallet loads and the flue spaces between them.

2.3.4.6.1.4 The use of a horizontal barrier generally reduces the number of in-rack sprinklers required per level; however, it does not reduce the number of in-rack levels required.

2.3.4.6.1.5 When horizontal barriers are to be installed, use minimum 22 ga (0.7 mm) sheet metal or minimum 3/8 in. (10 mm) plywood and arrange them to span from aisle face to aisle face as well as from rack upright

to rack upright, covering up any flue spaces that exist between the rack uprights. A maximum 3 in. (75 mm) wide gap is acceptable between horizontal barriers at the flue space created by the rack uprights.

2.3.4.6.2 Use the flowcharts in Figures 5, 5a, 6, 6a, and 7, depending on the type of rack to be protected, to determine the recommended horizontal in-rack sprinkler arrangement as follows:

- Figure 5: Single-row racks up to 3 ft (0.9 m) deep
- Figure 5a: Single-row racks over 3 ft (0.9 m) deep
- Figure 6: Double-row racks up to 9 ft (2.7 m) deep
- Figure 6a: Double-row racks over to 9 ft (2.7 m) deep
- Figure 7: Multiple-row racks.

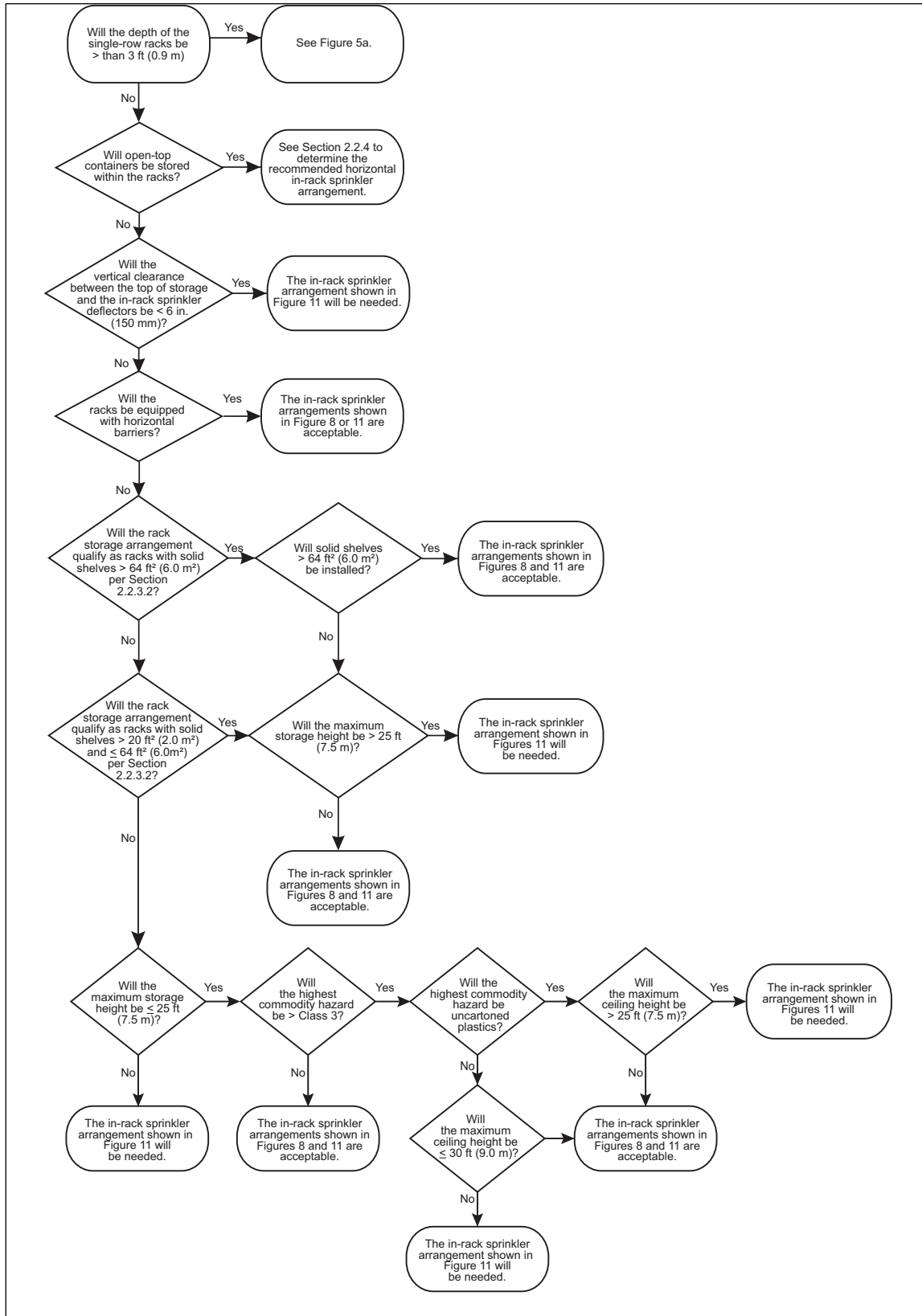

Fig. 5. Recommended horizontal in-rack sprinkler arrangements for single-row racks up to 3 ft (0.9 m) deep

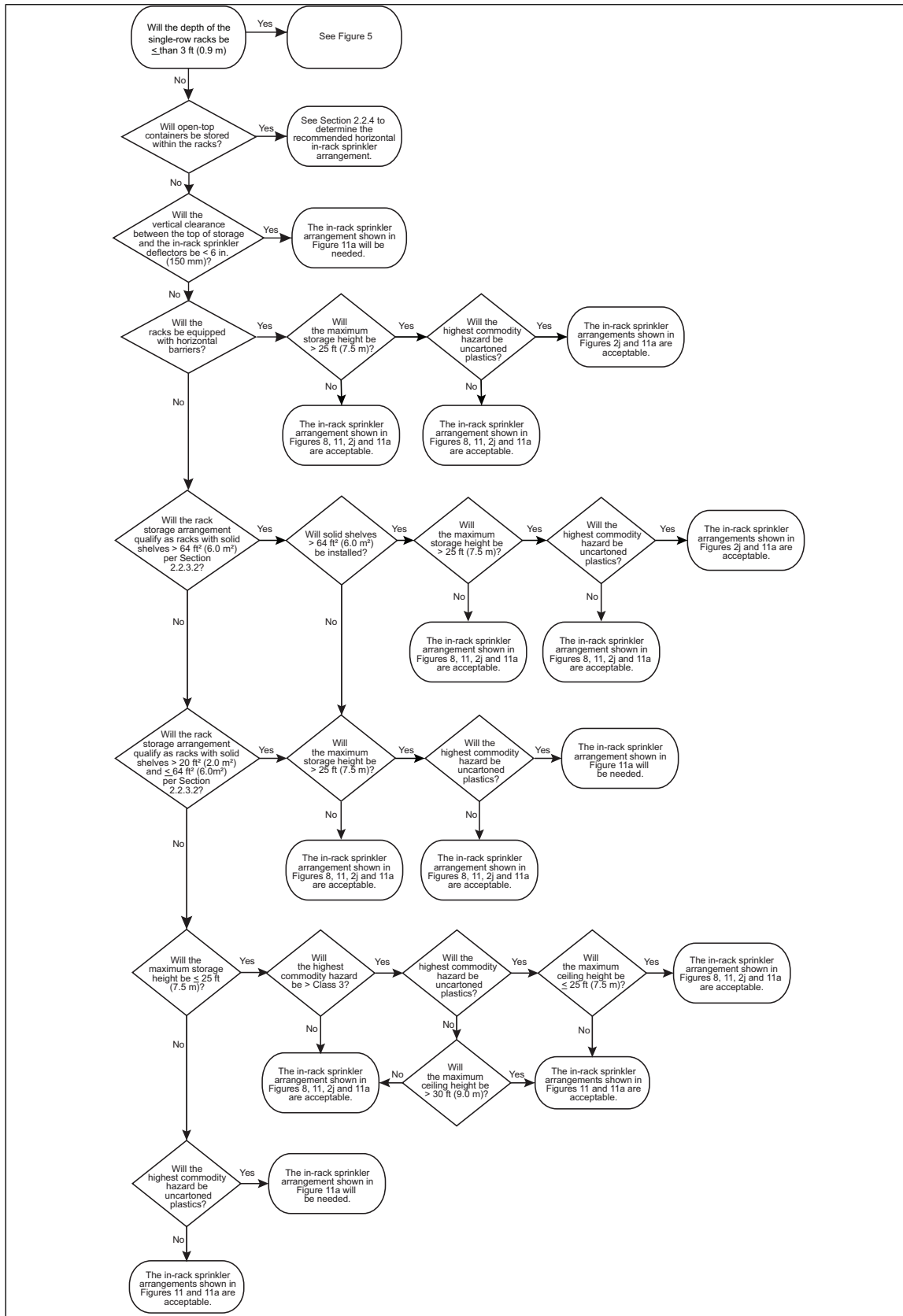

Fig. 5a. Recommended horizontal in-rack sprinkler arrangements for single-row racks over 3 ft (0.9 m) deep

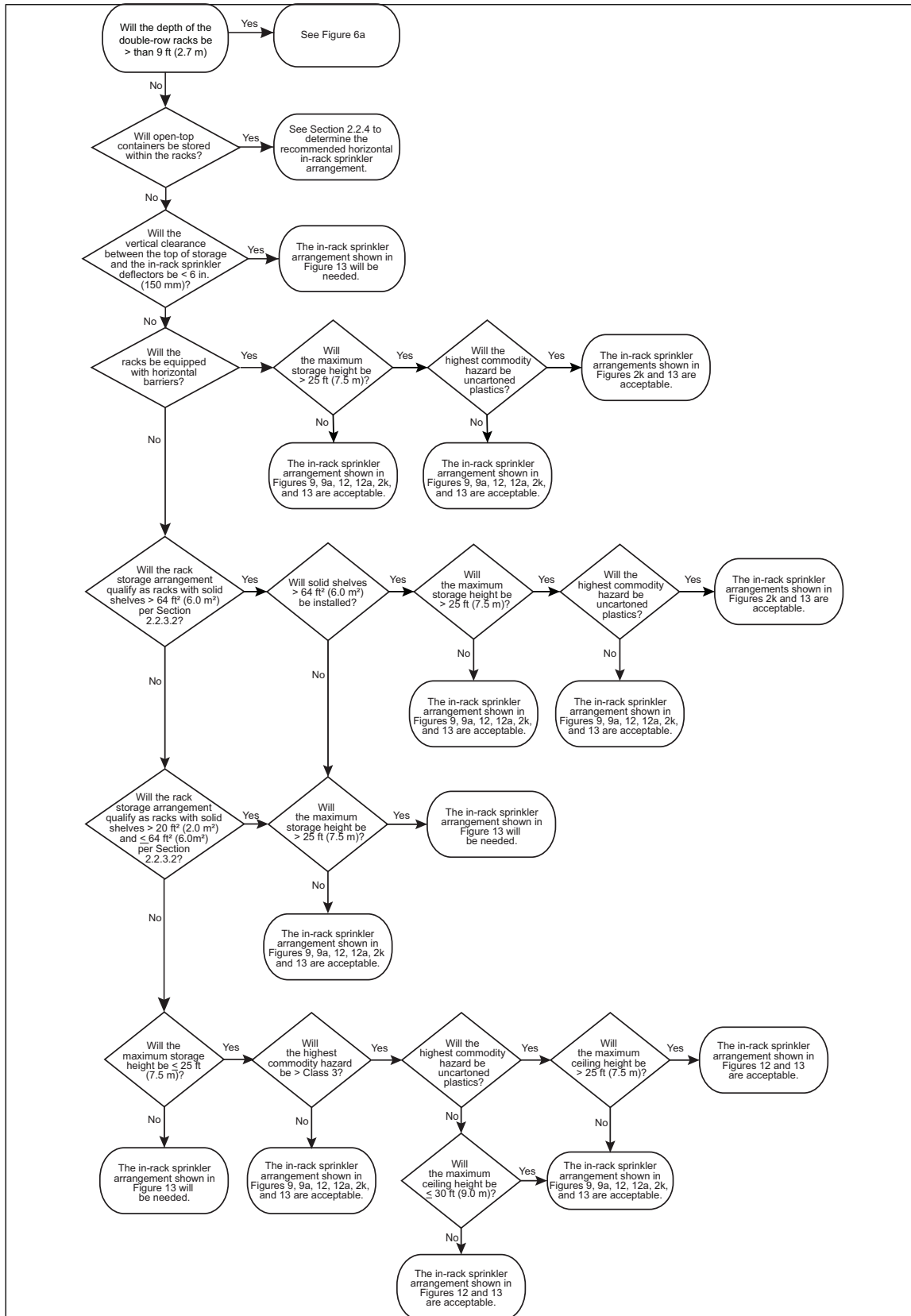

Fig. 6. Recommended horizontal in-rack sprinkler arrangements for double-row racks up to 9 ft (2.7 m) deep

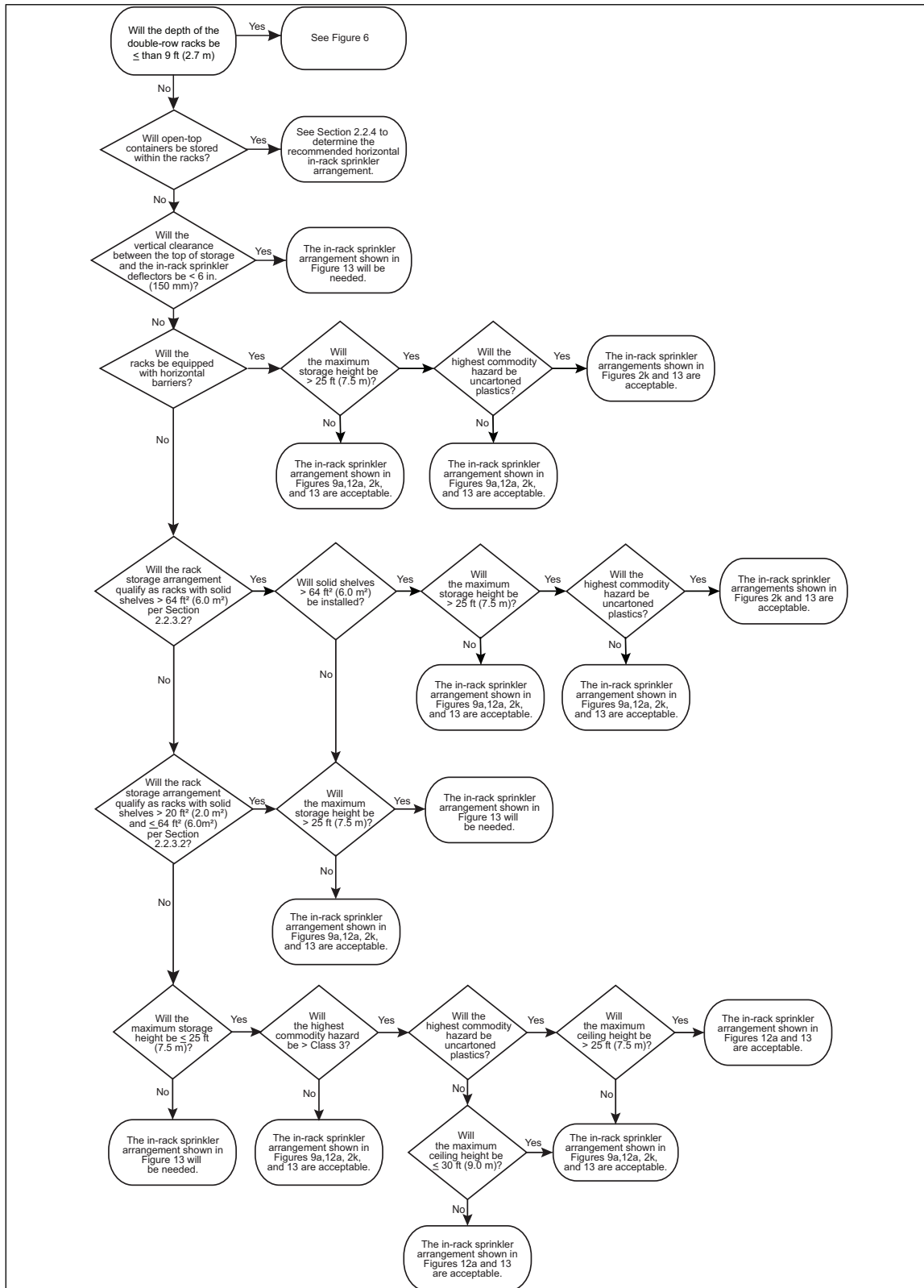

Fig. 6a. Recommended horizontal in-rack sprinkler arrangements for double-row racks over 9 ft (2.7 m) deep

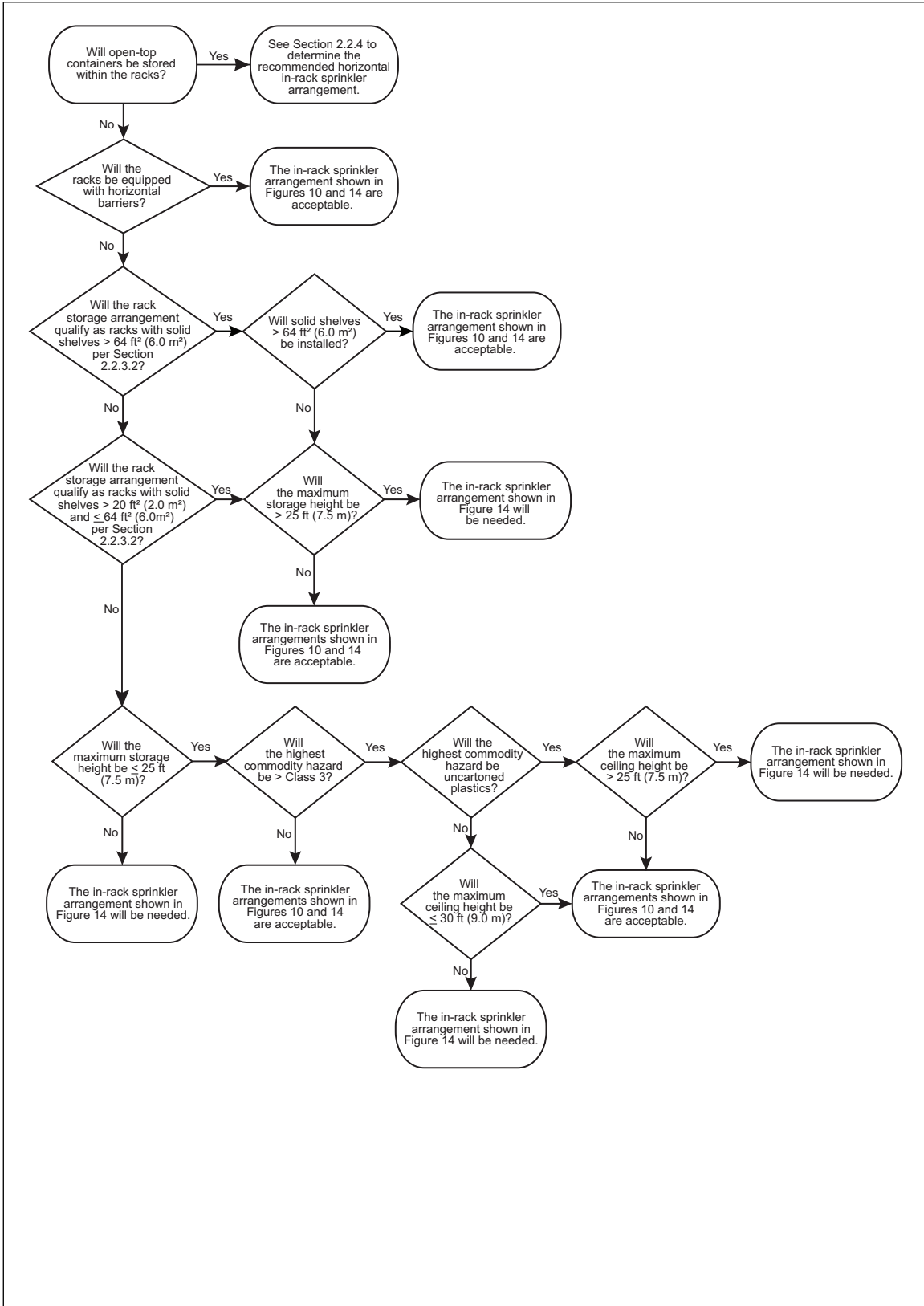

Fig. 7. Recommended horizontal in-rack sprinkler arrangements for multiple-row racks

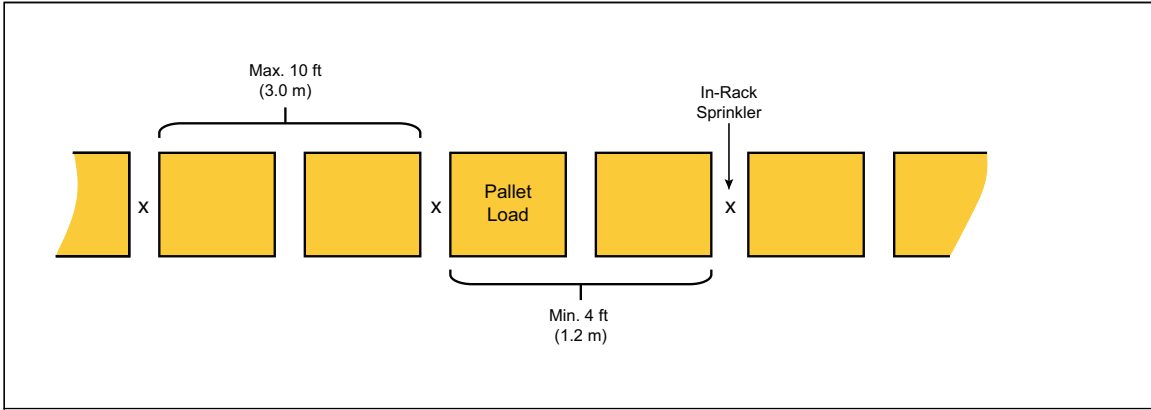

Fig. 8. Plan view of IRAS(EO) horizontal in-rack sprinkler arrangement for single-row racks

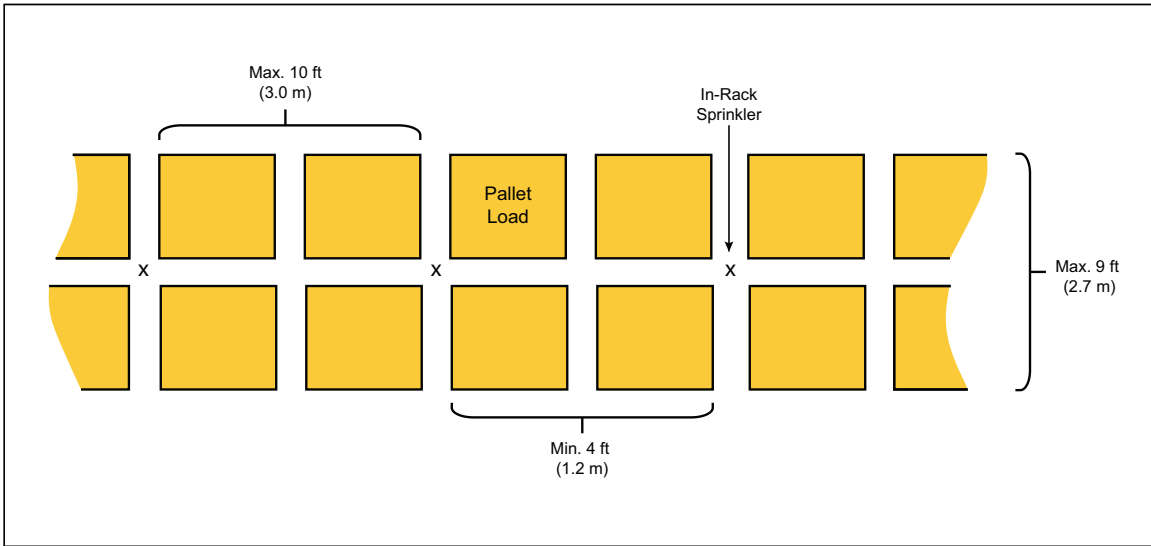

Fig. 9. Plan view of IRAS(EO) horizontal in-rack sprinkler arrangement for double-row racks up to 9 ft (2.7 m) deep

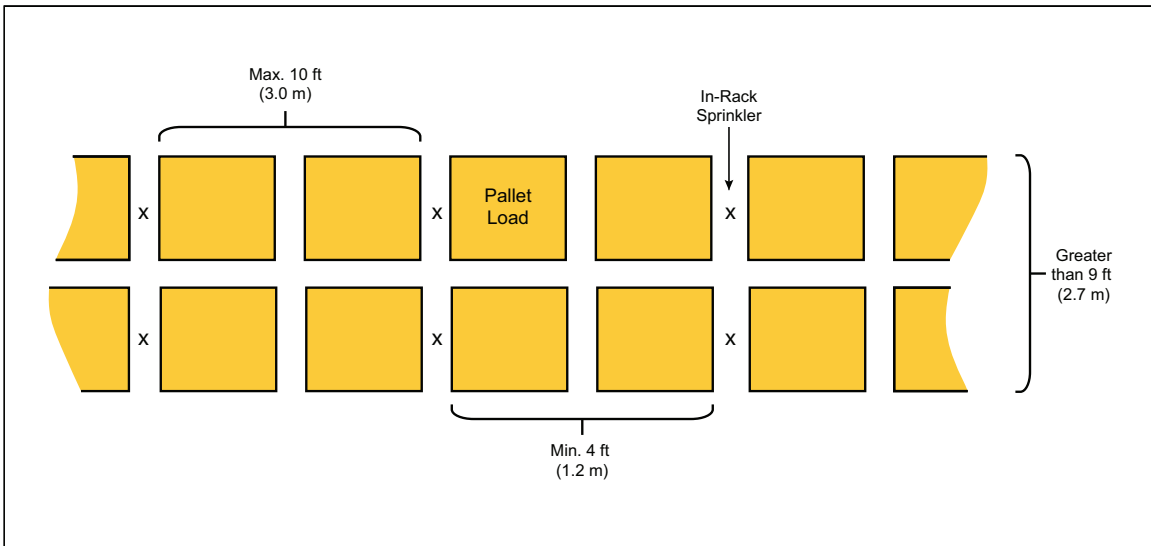

Fig. 9a. Plan view of IRAS(EO) horizontal in-rack sprinkler arrangement for double-row racks over 9 ft (2.7 m) deep

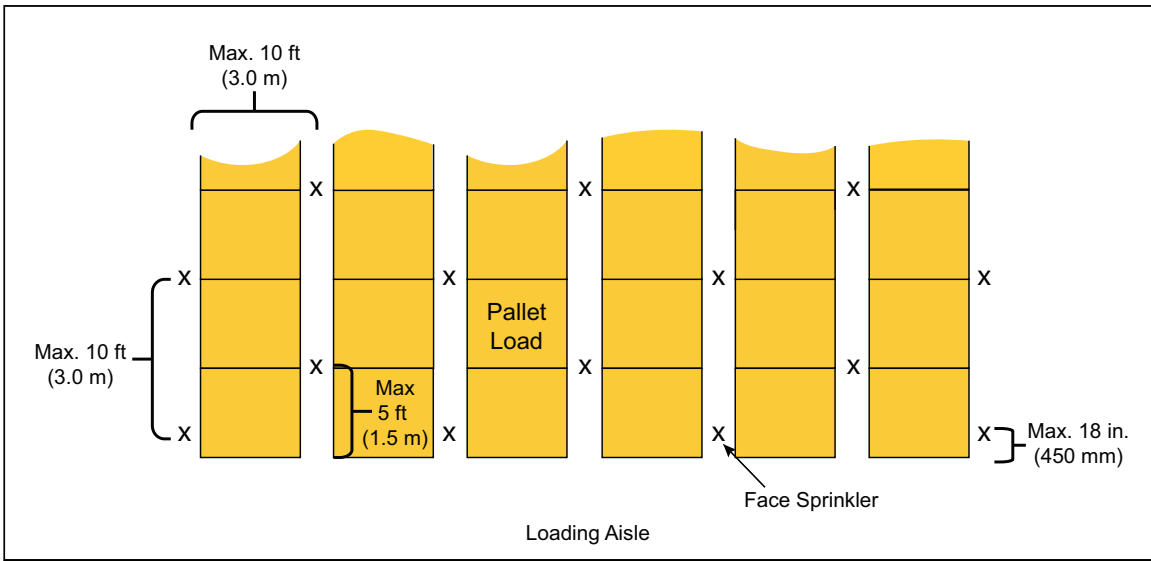

Fig. 10. Plan view of IRAS(EO) horizontal in-rack sprinkler arrangement for multiple-row racks

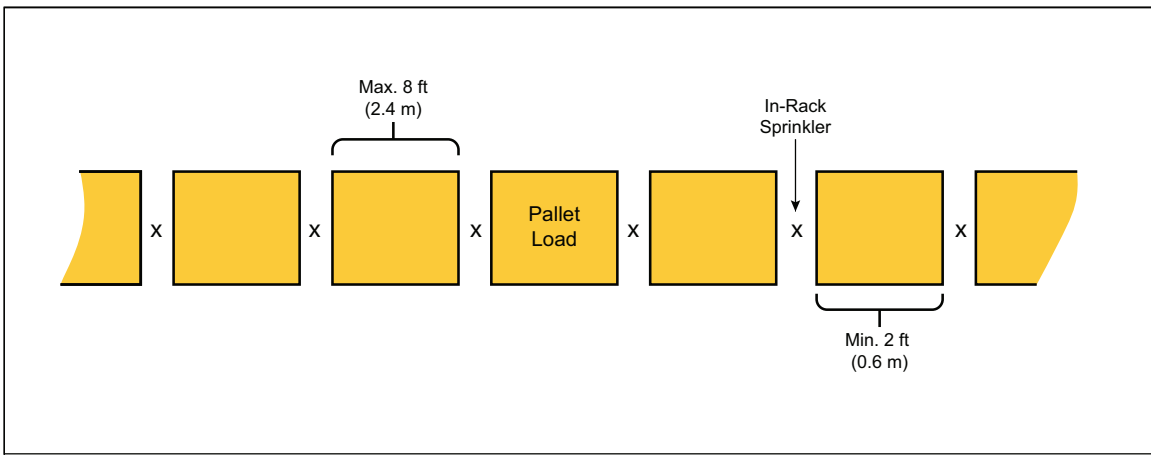

Fig. 11. Plan view of IRAS(E) horizontal in-rack sprinkler arrangement for single-row racks

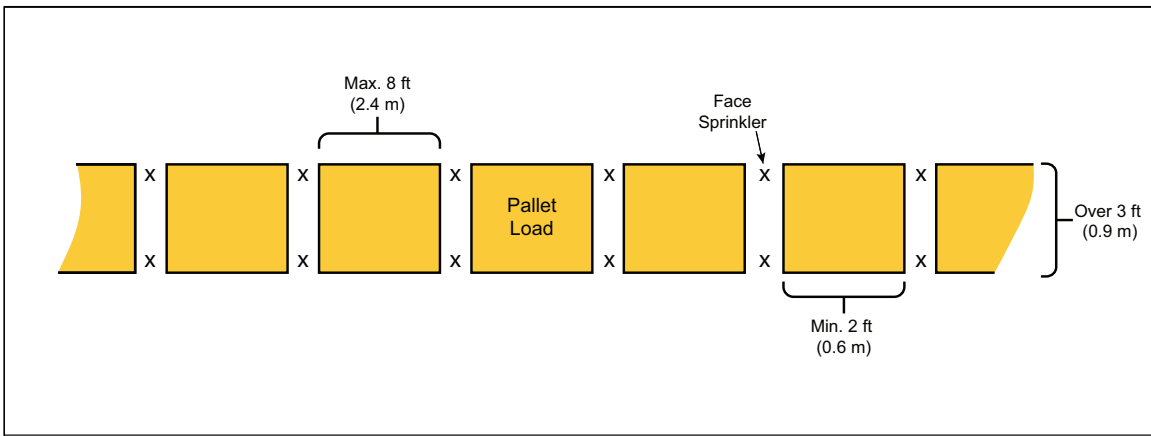

Fig. 11a. Plan view of IRAS(E) horizontal in-rack sprinkler arrangement for single-row racks over 3 ft (0.9 m) wide

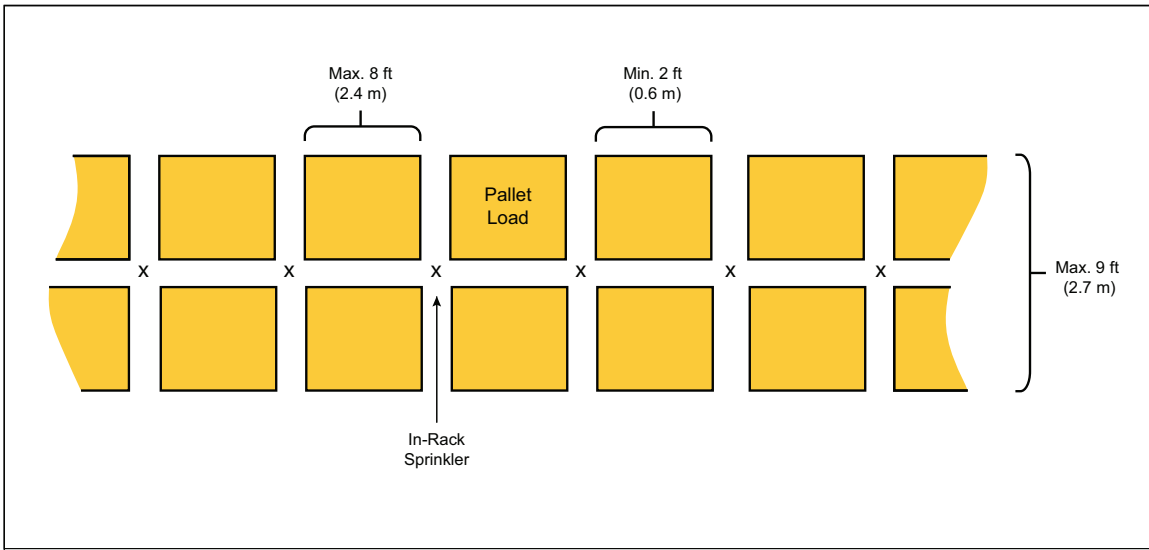

Fig. 12. Plan view of IRAS(E) horizontal in-rack sprinkler arrangement for double-row racks having a maximum depth of 9 ft (2.7 m)

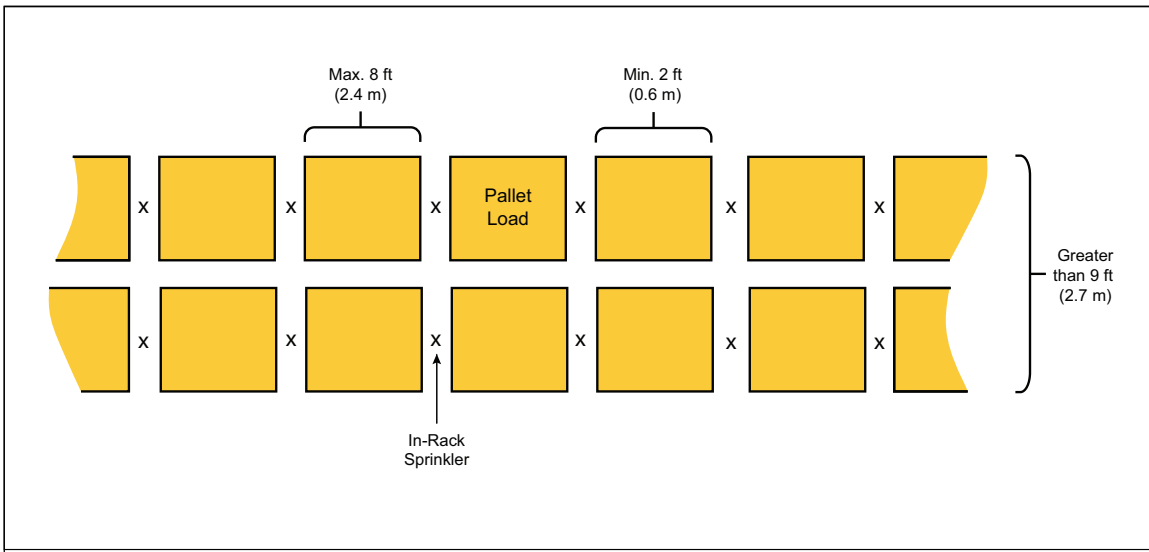

Fig. 12a. Plan view of IRAS(E) horizontal in-rack sprinkler arrangement for double-row racks over 9 ft (2.7 m) deep

2.3.4.6.3 See Section 2.2.4 to determine the recommended horizontal in-rack sprinkler arrangement when protecting open-top containers.

2.3.4.6.4 When the applicable flowchart indicates that an IRAS(EO) horizontal in-rack sprinkler arrangement is acceptable, but the horizontal distance between every other transverse flue space exceeds 10 ft (3.0 m), install in-rack sprinklers in every transverse flue space and, if needed, between every transverse flue space so that the maximum allowable horizontal distance between in-rack sprinklers does not exceed 10 ft (3.0 m).

2.3.4.6.5 When the applicable flowchart indicates that an IRAS(EO) horizontal in-rack sprinkler arrangement is acceptable, but the horizontal distance between every other transverse flue space is less than 4 ft (1.2 m), install in-rack sprinklers within the transverse flue spaces so that there is not more than 2 transverse flue spaces between in-rack sprinklers.

2.3.4.6.6 When the applicable flowchart indicates that an IRAS(E) horizontal in-rack sprinkler arrangement is acceptable, but the horizontal distance between every transverse flue space exceeds 8 ft (2.4 m), install

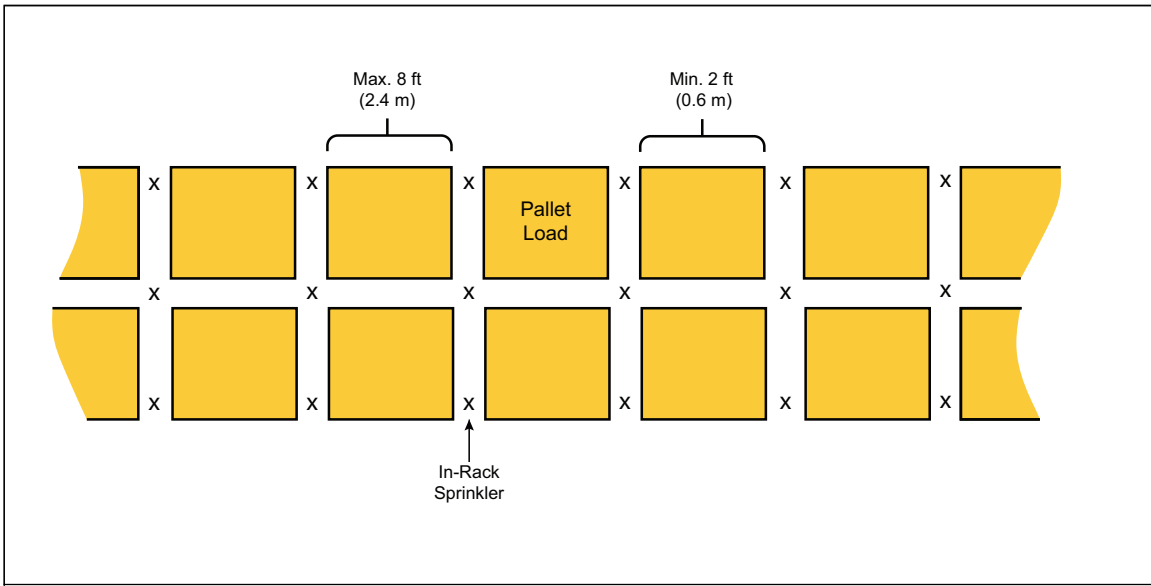

Fig. 13. Plan view of IRAS(E) horizontal in-rack sprinkler arrangement for double-row racks (face and flue)

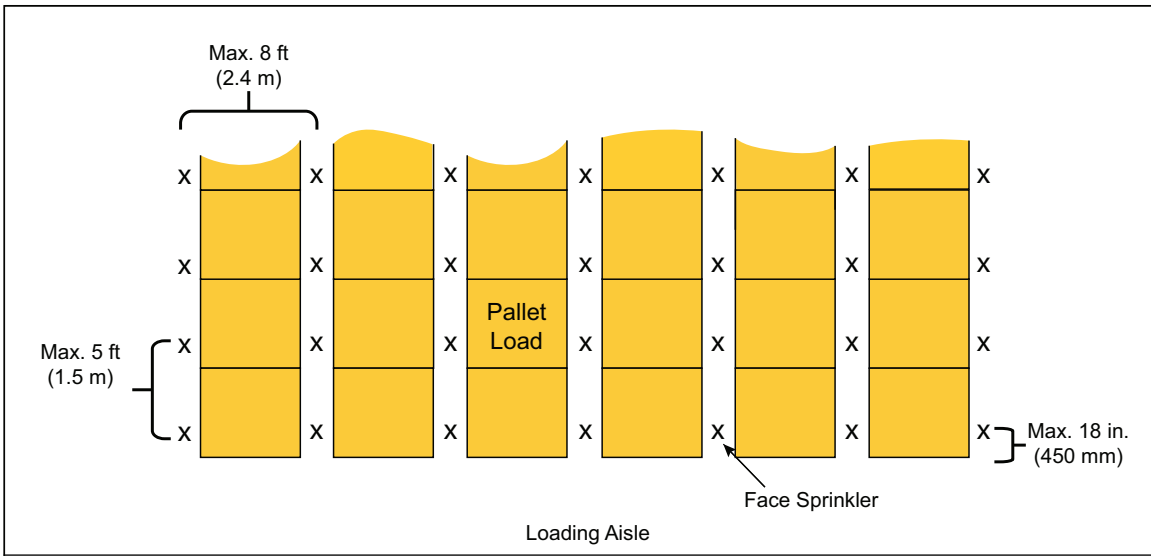

Fig. 14. Plan view of IRAS(E) horizontal in-rack sprinkler arrangement for multiple-row racks

in-rack sprinklers in every transverse flue space and between every transverse flue space so that the maximum allowable horizontal distance between in-rack sprinklers does not exceed 8 ft (2.4 m).

2.3.4.6.7 When the applicable flowchart indicates that an IRAS(E) horizontal in-rack sprinkler arrangement is acceptable, but the horizontal distance between every transverse flue space would be less than 2 ft (0.6 m), install in-rack sprinklers within the transverse flue spaces so that there is not more than 1 transverse flue space between in-rack sprinklers.

2.3.4.6.8 When solid shelves are present and in-rack sprinklers are recommended, position the in-rack sprinklers as close to the shelf openings as possible.

2.3.4.6.9 See Section 2.3.4.9 regarding in-rack sprinkler installation guidelines for Scheme 8-9A.

2.3.4.6.10 Horizontal In-Rack Sprinkler Arrangements in the Presence of Horizontal Barriers

2.3.4.6.10.1 When installed in combination with a horizontal barrier, in-rack sprinklers do not have to be positioned relative to the proximity of the transverse flue spaces unless:

A. There is less than 6 in. (150 mm) clearance between the top of storage and the deflector of the in-rack sprinkler, or

B. The hazard of open-top containers is present within the storage rack.

2.3.4.6.10.2 Arrange loads being stored within the racks such that they do not extend more than 3 in. (75 mm) beyond the edge of the horizontal barrier.

2.3.4.6.10.3 When loads being stored within the racks will extend more than 3 in. (75 mm) beyond the edge of the horizontal barrier, use a horizontal in-rack sprinkler arrangement that includes face sprinklers.

2.3.4.7 Vertical Increments of In-Rack Sprinklers

See Figure 15 to determine recommended vertical increments for in-rack sprinklers.

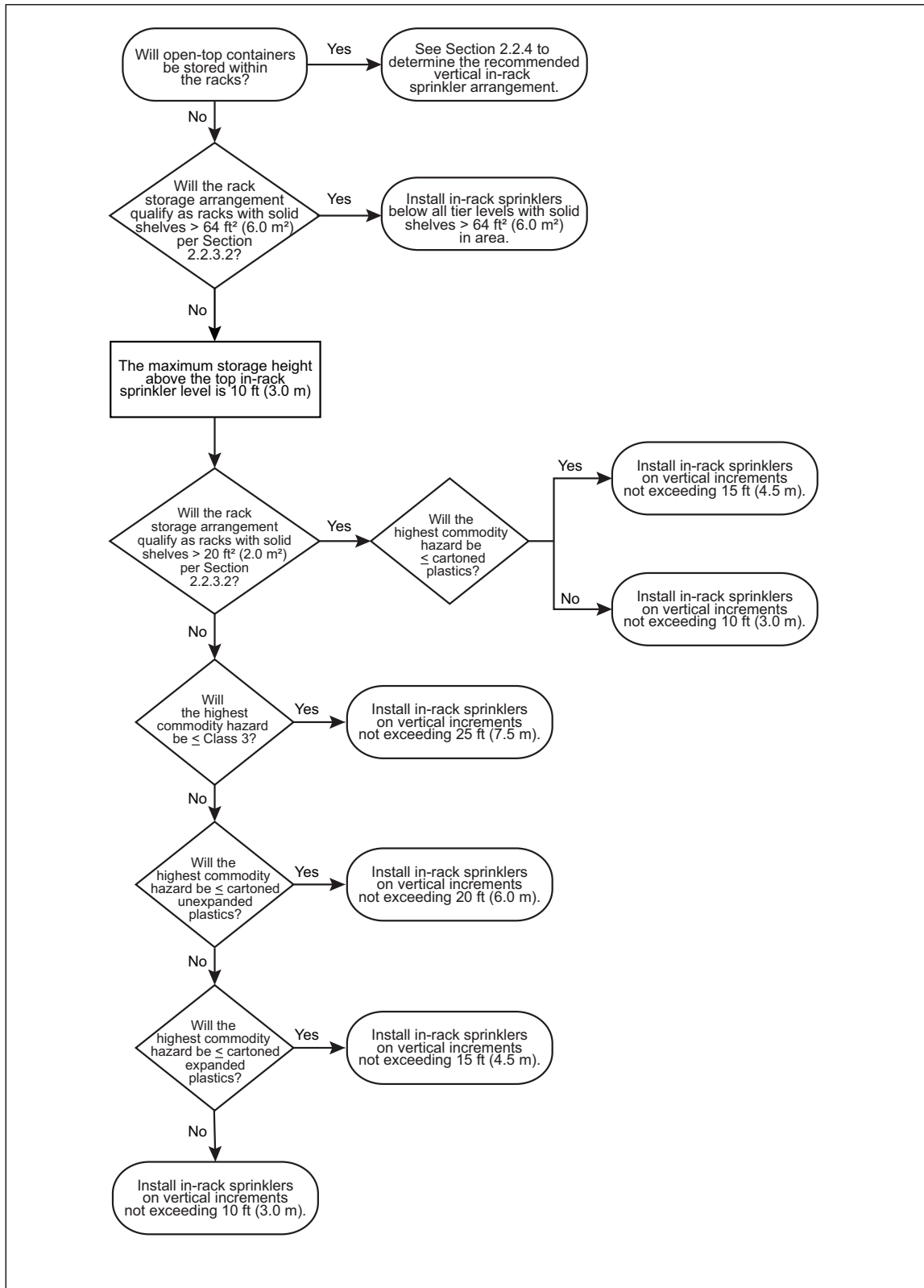

Fig. 15. Recommended vertical in-rack sprinkler increments

Note that when storage on the first tier level is maintained on a horizontal support, as opposed to directly on the floor, the allowable vertical distance obtained from Figure 15 can be measured vertically from the underside of the pallet load on the first tier level to the nearest in-rack sprinkler tier level.

2.3.4.8 Design Guidelines for Ceiling-Level and In-Rack Sprinklers

The design guidelines for in-rack sprinklers are dependent on the commodity being protected, the number of in-rack sprinkler levels installed, and the height of storage above the top level of in-rack sprinklers.

The design guidelines for ceiling-level sprinklers that are supplemented with in-rack sprinklers are dependent on the commodity being protected, the horizontal in-rack sprinkler layout provided, and the height of storage above the top level of in-rack sprinklers.

2.3.4.8.1 Design Guidelines for In-Rack Sprinklers

2.3.4.8.1.1 Design in-rack sprinkler systems per in Table 12.

2.3.4.8.1.2 Balance the in-rack sprinkler system water demand with the ceiling-level sprinkler water demand at the point where the two systems are connected.

2.3.4.8.1.3 Unless indicated otherwise, ensure the minimum operating pressure of the in-rack sprinklers is 7 psi (0.5 bar).

Table 12. Hydraulic Design for In-Rack Sprinkler Systems

| Commodity Hazard | Storage Height Above Top Level of IRAS, ft (m) | No. of Installed IRAS Levels | IRAS Design, No. of Sprinklers | IRAS Design, Min. Flow per Sprinkler, gpm (L/min) |
|----------------------|--|------------------------------|--------------------------------|---|
| Class 1-3 | ≤ 10 (3.0) | 1 | 6 | 22 (85) |
| | | 2 or more | 10 (5 on 2 levels) | 22 (85) |
| Class 4 and Plastics | ≤ 10 (3.0) | 1 | 8 | 30 (115) |
| | | 2 or more | 14 (7 on 2 levels) | 30 (115) |

2.3.4.8.1.4 Unless indicated otherwise in this data sheet, the maximum water delivery time for any dry-type in-rack sprinkler system is 60 seconds and is based on the operation of the hydraulically most remote in-rack sprinkler.

2.3.4.8.2 Design Guidelines for Ceiling-Level Sprinklers in Combination with In-Rack Sprinklers

2.3.4.8.2.1 When storage racks are protected with in-rack sprinklers in accordance with Section 2.3.4, obtain the applicable ceiling sprinkler system design using Table 13. Determine both (1) the applicable protection table (Tables 7, 8 or 10), and (2) the applicable ceiling height to use within the indicated protection table. Note that the protection table indicated by Table 13 may **not** be specific to the commodity hazard being protected.

Table 13. Determining Applicable Protection Table and Ceiling Height for Ceiling Sprinkler Designs when Ceiling-Level Sprinkler Systems are Supplemented with In-Rack Sprinklers

| Commodity Hazard | IRAS Arrangement | Maximum Storage Height Above Top IRAS Level, ft (m) | Maximum Clearance Between Top of Storage and Ceiling, ft (m)* | Applicable Ceiling-Level Sprinkler Protection Table | Ceiling Height in Applicable Protection Table, ft (m) |
|--|------------------|---|---|---|---|
| Class 1, 2 and 3 | IRAS(EO) | 5 (1.5) | 5 (1.5) | 7 | 10 (3.0) |
| | | | 20 (6.0) | 7 | 20 (6.0) |
| | | 10 (3.0) | 20 (6.0) | 7 | 20 (6.0) |
| | IRAS(E) | 5 (1.5) | 10 (3.0) | 7 | 10 (3.0) |
| | | | 20 (6.0) | 7 | 20 (6.0) |
| | | 10 (3.0) | 20 (6.0) | 7 | 20 (6.0) |
| Class 4, Cartoned Unexpanded Plastics and Cartoned Expanded Plastics | IRAS (EO) | 5 (1.5) | 5 (1.5) | 8 | 10 (3.0) |
| | | | 20 (6.0) | 8 | 15 (4.5) |
| | | 10 (3.0) | 15 (4.5) | 8 | 15 (4.5) |
| | IRAS (E) | 5 (1.5) | 10 (3.0) | 8 | 10 (3.0) |
| | | | 20 (6.0) | 8 | 15 (4.5) |
| | | 10 (3.0) | 20 (6.0) | 8 | 15 (4.5) |
| Uncartoned Unexpanded Plastics and Uncartoned Expanded Plastics | IRAS (EO) | 5 (1.5) | 5 (1.5) | 8 | 10 (3.0) |
| | | | 20 (6.0) | 8 | 15 (4.5) |
| | | 10 (3.0) | 5 (1.5) | 8 | 15 (4.5) |
| | | | 15 (4.5) | 10 | 15 (4.5) |
| | IRAS (E) | 5 (1.5) | 5 (1.5) | 8 | 10 (3.0) |
| | | | 20 (6.0) | 8 | 15 (4.5) |
| | | 10 (3.0) | 5 (1.5) | 8 | 15 (4.5) |
| | | | 10 (3.0) | 8 | 20 (6.0) |
| | | 15 (4.5) | 10 | 15 (4.5) | |
| | | 20 (6.0) | 10 | 20 (6.0) | |

* When this distance is greater than 20 ft (6.0 m), see Section 2.3.3.7.3 for guidance.

2.3.4.8.2.2 Use the ceiling height indicated for an IRAS(E) arrangement when in-rack sprinklers are used in combination with horizontal barriers or when in-rack sprinklers are installed under solid shelves.

2.3.4.8.2.3 Balance the ceiling-level sprinkler system water demand with the in-rack sprinkler system water demand at the point where the two systems are connected.

2.3.4.9 Design Guidelines for Fire Protection Scheme 8-9A

See Appendix A, Fire Protection Scheme 8-9A, for a description of the intent of this protection arrangement as well as an example of its use.

2.3.4.9.1 Dedicated Storage Rack

Establish a dedicated storage rack (or racks) where all of the high-challenge commodities will be maintained. If this storage rack will not be solely dedicated to the storage of high-challenge commodities then either (1) extend the Fire Protection Scheme 8-9A (i.e. Scheme 8-9A) protection horizontally one pallet load in all directions beyond the designated high-challenge commodities storage area, or (2) install a vertical barrier to segregate the high-challenge commodities from any adjacent commodities.

Commodities that can be protected by the ceiling-level sprinkler system can be stored vertically above as well as horizontally adjacent to the portions of the storage rack equipped with Scheme 8-9A protection.

2.3.4.9.2 Horizontal Barriers

Install horizontal barriers in accordance with Section 2.3.4.6.1.5. Horizontal barriers are needed at every tier level of the dedicated storage rack if the rack is equipped with solid shelves. If the dedicated storage rack is open-frame (see Section 2.2.3.2 for the guidelines that allow storage racks to be treated as open-frame rack storage) the maximum vertical distance between horizontal barriers is 12 ft (3.6 m).

2.3.4.9.3 In-Rack Sprinklers

Install minimum K8.0 (K115) FM Approved, quick-response sprinklers fed only by a wet sprinkler system beneath each horizontal barrier. Locate the thermal element of the in-rack sprinkler no more than 9 in. (225 mm) vertically below the underside of the horizontal barrier.

For single-row racks, install sprinklers at each rack upright as well as at each rack mid-bay as shown in Figure 16. The maximum linear spacing between sprinklers is 5 ft (1.5 m).

For double-row racks, install sprinklers at each rack upright within the longitudinal flue space as well as at the face of the rack. In addition, install sprinklers at the mid-bay face of each rack bay as shown in Figure 17. The maximum linear spacing between sprinklers is 5 ft (1.5 m) at the rack face and 10 ft (3.0 m) within the longitudinal flue space.

For multiple-row racks, install an alternating IRAS(E)/IRAS(EO) sprinkler arrangement within adjacent transverse flue spaces as shown in Figure 18. Note that sprinklers are needed at the face of each flue space. The maximum linear spacing between sprinklers using an IRAS(E) sprinkler arrangement is 5 ft (1.5 m) and 10 ft (3.0 m) between sprinklers using an IRAS(EO) sprinkler arrangement.

Base the design the in-rack sprinkler system on a minimum flow of 60 gpm (230 L/min) from the most remote 6 sprinklers for single-row racks or the most remote 8 sprinklers for both double-row and multiple-row racks. Include a hose demand allowance of 250 gpm (950 L/min) for manual intervention. Provide the combined water demand (in-rack and hose demand) for at least one hour. Note that the in-rack sprinkler demand (1) does not have to be hydraulically balanced with the ceiling-level sprinkler system, and (2) does not have to be accounted for operating simultaneously with the ceiling-level sprinkler system.

2.3.4.9.4 Ceiling Sprinkler System

Design the ceiling-level sprinkler system as outlined in this data sheet based on the highest commodity hazard not protected by the Scheme 8-9A protection, or by the applicable occupancy-specific data sheet when the surrounding occupancy is not addressed by Data Sheet 8-9.

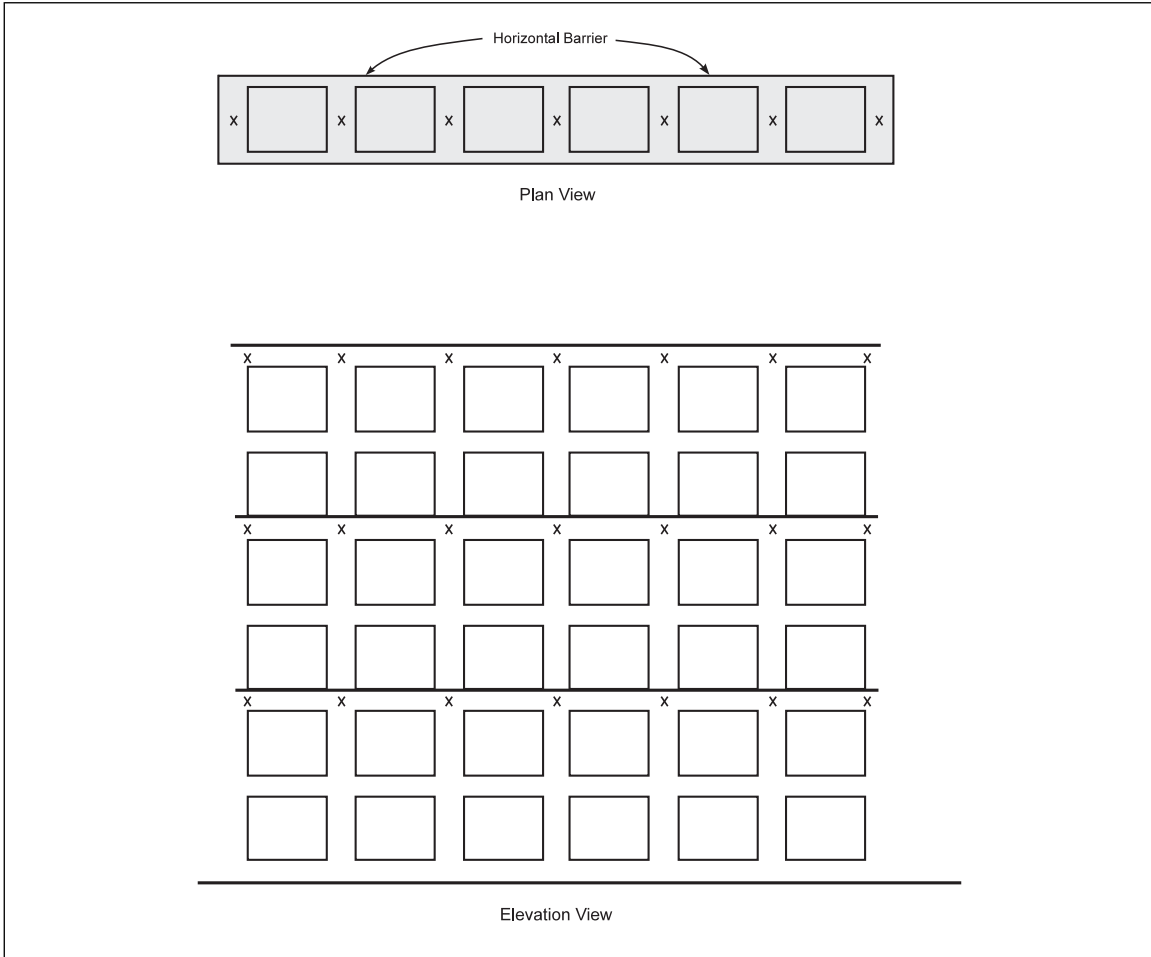

Fig. 16. Fire Protection Scheme 8-9A within single-row racks

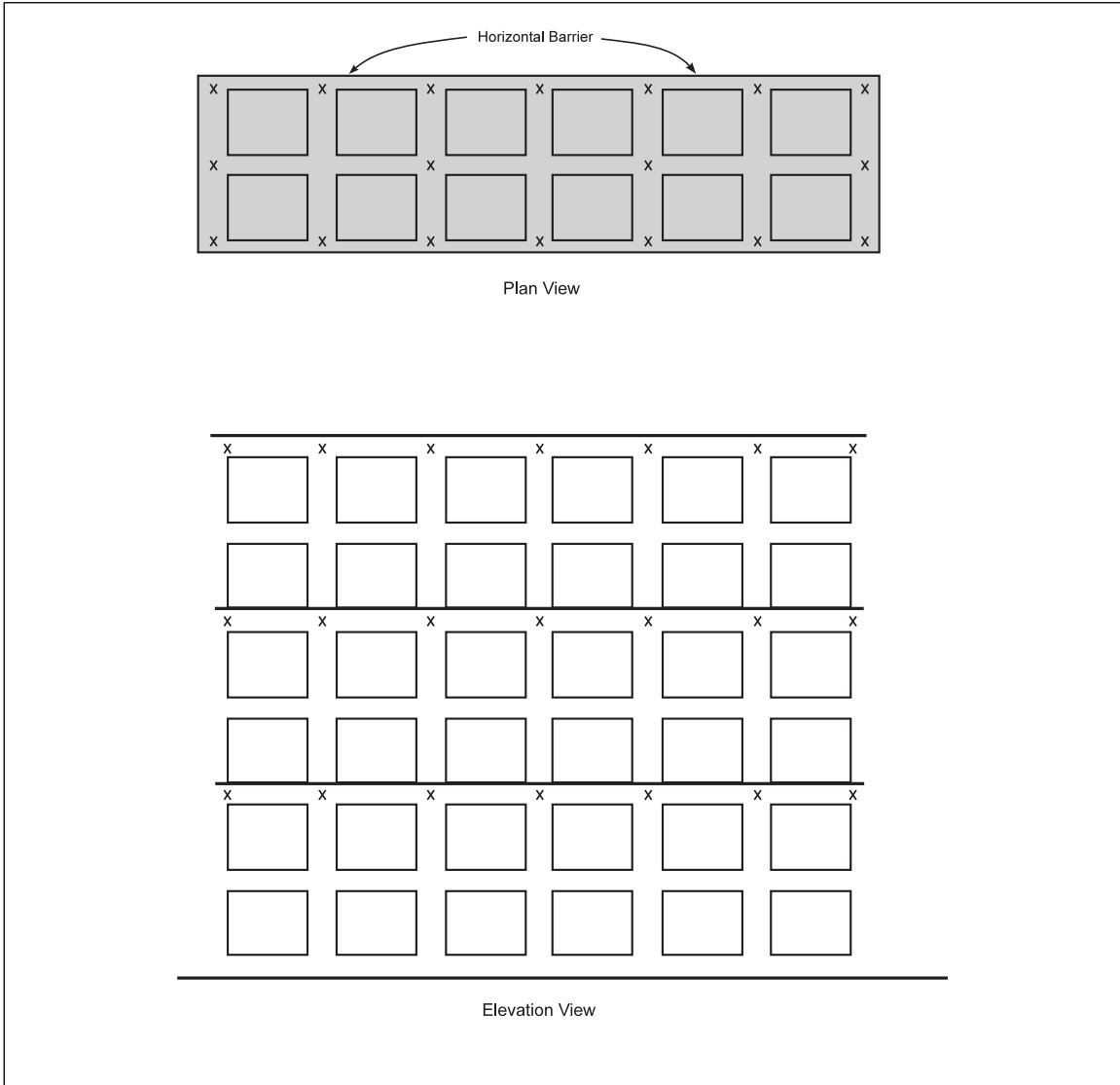

Fig. 17. Fire Protection Scheme 8-9A within double-row racks

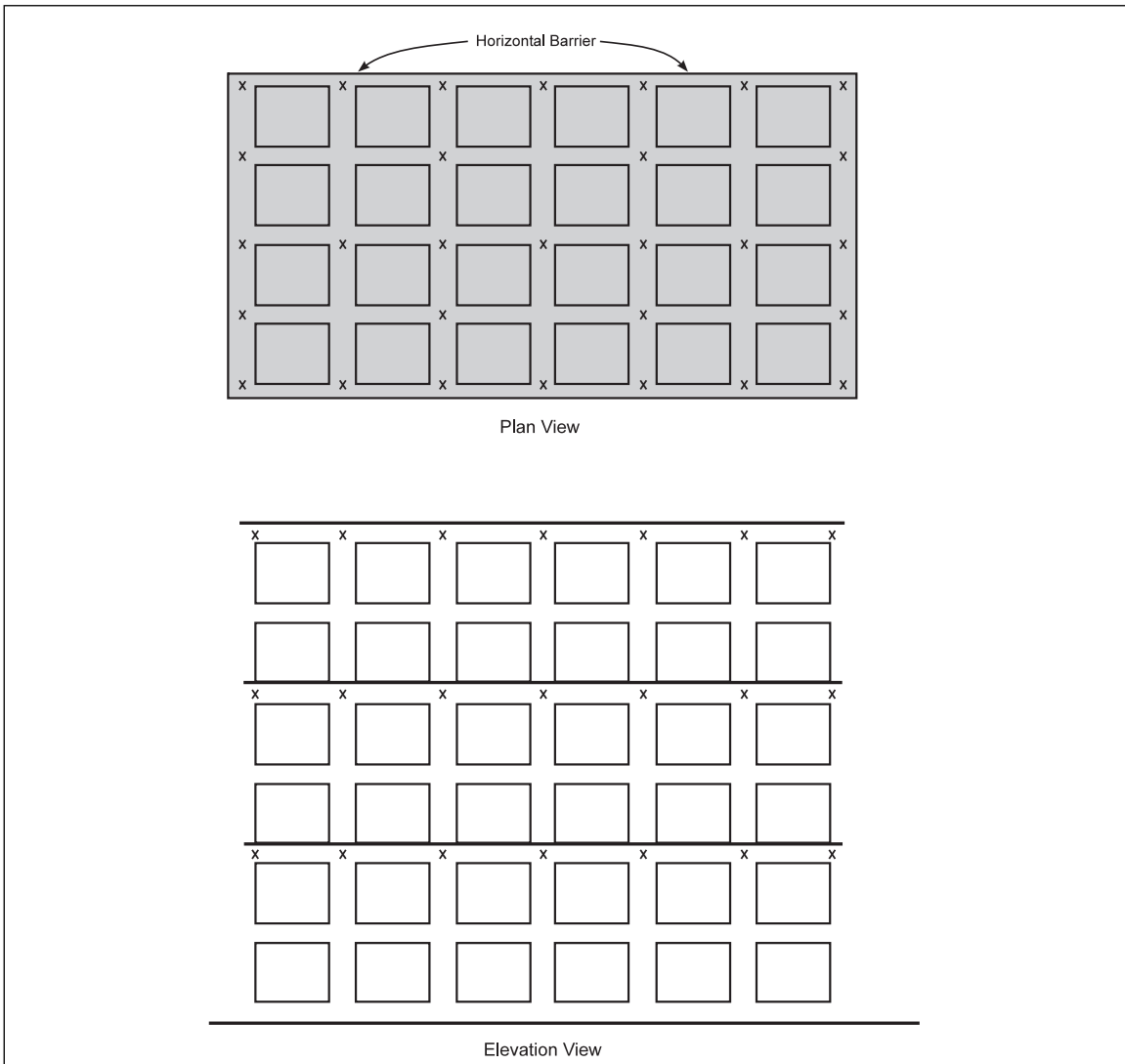

Fig. 18. Fire Protection Scheme 8-9A within multiple-row racks

2.3.5 Hose Demands, Hose Connections, and System Duration

2.3.5.1 Hose Demand and System Duration

2.3.5.1.1 See Table 14 to determine the recommended hose demand for system design purposes that account for potential manual intervention. Allow at least 100 gpm (380 L/min) for inside hose stream usage, when provided, and add the balance of the hose demand to the overall sprinkler demand at the point of connection.

2.3.5.1.2 In addition, ensure the water supplies are capable of providing the combined sprinkler system (ceiling and, if provided, in-rack) and hose demands at adequate pressure per the duration guidelines in Table 14.

Table 14. Hose Demand and Water Supply Duration Design Guidelines

| Sprinkler Type by Spacing | No. of Sprinklers in Ceiling Design | Hose Demand, gpm (L/ min) | Duration, min |
|---------------------------|-------------------------------------|---------------------------|---------------|
| Standard-coverage | Up to 12 | 250 (950) | 60 |
| | 13 to 19 | 500 (1,900) | 90 |
| | 20 or more | 500 (1,900) | 120 |
| Extended-coverage | Up to 6 | 250 (950) | 60 |
| | ^a 7 to 9 | 500 (1,900) | 90 |
| | 10 or more | 500 (1,900) | 120 |

^a When the maximum linear spacing is 12 ft (3.7 m), the hose demand can be 250 gpm (950 L/min) and the duration can be 60 minutes.

2.3.5.2 Hose Connections

Provide permanent small hose lines (1-1/2 in. [40 mm]) not exceeding 100 ft (30 m) in length, capable of reaching all storage areas to aid in potential initial-stage firefighting as well as for after-extinguishment mop-up operations. Supply small hose lines from any of the following:

- a. A separate piping system for small hose stations, or
- b. Valved hose connections on sprinkler risers where such connections are made upstream from all sprinkler control valves, or
- c. Adjacent sprinkler systems, or
- d. Ceiling sprinklers in the protected area when separately controlled in-rack sprinklers are provided

It may be preferable from an operations standpoint to locate hose stations on the ends of racks or storage piles rather than in aisles.

In freezers, or other areas subject to freezing, consider the number, location, and arrangement of hose stations.

2.3.6 Special Applications

2.3.6.1 Ceiling-Only Sprinkler Protection for Class 1, 2 and 3 Commodities Protected by Dry-Pipe and Similar Sprinkler Systems for Ceiling Heights Over 30 ft (9.0 m)

In addition to the protection design guidelines in Tables 2 and 7 for the protection of Class 1, 2, and 3 commodities by ceiling-level sprinklers on dry-pipe and similar sprinkler systems in storage areas having a maximum ceiling height of 30 ft (9.0 m) in Table 2 and 7, ceiling-level protection without the need for in-rack sprinklers is also available for these commodities for ceiling heights over 30 ft (9.0 m) and up to 55 ft (16.5 m) high in accordance with this section.

2.3.6.1.1 Acceptable storage arrangements include solid-piled, palletized, shelf, bin-box, and open-framed racks. Note that push-back type flow-through racks do not qualify as open frame racks for this protection guidance.

2.3.6.1.2 Use FM Approved, upright, standard-response ceiling-level Storage sprinklers having a nominal temperature rating of 280°F (140°C) on a tree-type dry-pipe or similar sprinkler system. Dry-pipe, non-interlocked pre-action and single-interlock pre-action sprinkler systems are acceptable for ambient temperatures that will not drop below 16°F (-9°C). For ambient temperatures that can drop below 16°F (-9°C) install sprinklers only on a refrigerated area sprinkler system that is in accordance with Data Sheet 2-0, *Installation Guidelines for Automatic Sprinklers*.

2.3.6.1.3 If sprinkler protection will be installed using non-interlocked pre-action, single-interlocked pre-action or refrigerated-area sprinkler systems, follow the guidelines outlined in Data Sheet 5-48, *Automatic Fire Detection* and Data Sheet 2-0, *Installation Guidelines for Automatic Sprinklers*, regarding the proper installation of the detection system that will be used for releasing the pre-action valve.

2.3.6.1.4 See Table 14a to determine the available ceiling-level sprinkler system design options for Class 1 and 2 commodities or Table 14b for Class 3 commodities.

8-9 Storage of Class 1, 2, 3, 4 and Plastic Commodities

Table 14a. Ceiling-Level Sprinkler System Designs for Class 1 and 2 Commodities Protected by Dry-Pipe and Similar Sprinkler Systems

| Max. Ceiling Height, ft (m) | Storage Arrangement | Ceiling-Level Sprinkler | Min. Rack Aisle Width, ft (m) | Sprinkler System Design, No. of AS @ Min. Pressure, psi (bar) | Max. Water Delivery Time | Hose Demand, gpm (L/min) | System Duration, minutes |
|-----------------------------|---|-------------------------|-------------------------------|---|--------------------------|--------------------------|--------------------------|
| 40 (12.0) | Solid Piled, Palletized, Shelf, Bin-Box and Open-Frame Racks* | K11.2 (K160) | 8 (2.4) | 36 @ 55 (3.8) | 30 | 500 (1900) | 120 |
| | | K16.8 (K240) | 8 (2.4) | 36 @ 22 (1.5) | 30 | 500 (1900) | 120 |
| | | K25.2 (K360) | 4 (1.2) | 24 @ 15 (1.0) | 25 | 500 (1900) | 120 |
| | | | 6 (1.8) | 12 @ 50 (3.5) | 20 | 500 (1900) | 90 |
| | | K33.6 (K480) | 6 (1.8) | 12 @ 50 (3.5) | 20 | 500 (1900) | 90 |
| 45 (13.5) | Solid Piled, Palletized, Shelf, Bin-Box and Open-Frame Racks* | K25.2 (K360) | 6 (1.8) | 12 @ 50 (3.5) | 20 | 500 (1900) | 90 |
| | | K33.6 (K480) | 6 (1.8) | 12 @ 50 (3.5) | 20 | 500 (1900) | 90 |
| 50 (15.0) | Solid Piled, Palletized, Shelf, Bin-Box and Open-Frame Racks* | K33.6 (K480) | 8 (2.4) | 15 @ 50 (3.5) | 20 | 500 (1900) | 90 |
| 55 (16.5) | Solid Piled, Palletized, Shelf, Bin-Box and Open-Frame Racks* | K33.6 (K480) | 8 (2.4) | 16 @ 50 (3.5) | 20 | 500 (1900) | 120 |

* See the guidelines in Section 2.2.3.2 to confirm that any multiple-row racks being protected in accordance with this table meet the requirements to be considered open-frame.

Table 14b. Ceiling-Level Sprinkler System Designs for Class 3 Commodities Protected by Dry-Pipe and Similar Sprinkler Systems

| Max. Ceiling Height, ft (m) | Storage Arrangement | Ceiling-Level Sprinkler | Min. Rack Aisle Width, ft (m) | Sprinkler System Design, No. of AS @ Min. Pressure, psi (bar) | Max. Water Delivery Time | Hose Demand, gpm (L/min) | System Duration, minutes |
|-----------------------------|---|-------------------------|-------------------------------|---|--------------------------|--------------------------|--------------------------|
| 40 (12.0) | Solid Piled, Palletized, Shelf, Bin-Box and Open-Frame* Racks | K25.2 (K360) | 4 (1.2) | 24 @ 15 (1.0) | 25 | 500 (1900) | 120 |
| | | | 6 (1.8) | 12 @ 50 (3.5) | 20 | 500 (1900) | 90 |
| | | K33.6 (K480) | 8 (2.4) | 15 @ 50 (3.5) | 20 | 500 (1900) | 90 |
| 45 (13.5) | Solid Piled, Palletized, Shelf, Bin-Box and Open-Frame Racks* | K25.2 (K360) | 6 (1.8) | 12 @ 50 (3.5) | 20 | 500 (1900) | 90 |
| | | K33.6 (480) | 6 (1.8) | 12 @ 50 (3.5) | 20 | 500(1900) | 90 |
| 50 (15.0) | Solid Piled, Palletized, Shelf, Bin-Box and Open-Frame Racks* | K33.6 (K480) | 8 (2.4) | 15 @ 50 (3.5) | 20 | 500 (1900) | 90 |
| 55 (16.5) | Solid Piled, Palletized, Shelf, Bin-Box and Open-Frame Racks* | K33.6 (K480) | 8 (2.4) | 16 @ 50 (3.5) | 20 | 500 (1900) | 120 |

* See the guidelines in Section 2.2.3.2 to confirm that any multiple-row racks being protected in accordance with this table meet the requirements to be considered open-frame.

See Section 2.3.2.5 to determine how many open remote ceiling-level sprinklers to use for the purpose of calculating the maximum water delivery time.

2.3.6.1.5 To achieve the maximum water delivery time indicated above in Tables 14a and 14b, experience to date has demonstrated that the size of the sprinkler system will need to be limited to approximately 12,000 ft² (1,110 m²). Validate the maximum water delivery time before the start of any work by submitting copies of all plans, calculations, water supply details, and equipment details to the local FM service office for computer analysis. Specific details needed for this evaluation include:

- a) Manufacturer and model designation for the dry-pipe or pre-action valve
- b) Manufacturer and model designation for the dry-pilot actuator, as well as response characteristics, including performance criteria that relates actuation time to air pressure setting and static water pressure
- c) Air pressure to be maintained within the sprinkler piping

Note that all FM Approved pre-action and refrigerated-area sprinkler systems must be provided with all trim and accessories included as part of the Approval package. Contact the local FM service office before sending the information.

2.3.6.1.6 Handle all other plan review details through normal procedures as described in Data Sheet 2-0, *Installation Guidelines for Automatic Sprinklers*.

2.3.6.2 Retail/Big-Box Warehouse Occupancies

Retail/big-box warehouse occupancies typically have full or partial pallet loads in the top tiers of the racks. These pallet loads are broken down as needed to replenish individual stock items in the lower tiers. Lower tiers have slatted or solid shelving, while upper tiers may have slatted, wire mesh, or open shelving. Rack arrangements with certain combinations of slatted, wire mesh, or open shelves that do not qualify as open-frame racks per Section 2.2.3.2 can nevertheless be protected as open-frame rack storage with open shelves if they meet the conditions described in Sections 2.3.6.2.1 and 2.3.6.2.2.

2.3.6.2.1. Protect rack storage up to 20 ft (6.0 m) high as rack storage with open shelves when all of the following conditions are met:

- a) Slatted shelves are provided, they are fixed-in-place and provide a minimum 3 in. (75 mm) wide transverse flue space, and
- b) There are no solid shelf levels above the 12 ft (3.6 m) height in the rack (although there may be other open shelf or wire mesh shelf levels above), and
- c) Transverse flue spaces are a minimum 3 in. (75 mm) wide and are provided no more than 10 ft (3.0 m) apart horizontally, and
- d) The storage commodity does not consist of uncartoned plastics.

2.3.6.2.2. Provide longitudinal flue spaces if slatted shelf openings and transverse flue spaces do not run completely through the racks.

2.3.6.2.3. If the stored commodities include aerosols or flammable or combustible liquids, adhere to the recommendations in the relevant occupancy-related data sheet.

2.3.6.3 Protection of Class 1, 2, 3, 4 and Cartoned Plastics in Open-Frame Single and Double-Row Racks Using In-Rack Sprinklers Only in the Longitudinal Flue Space

2.3.6.3.1 Class 1, 2, 3, 4 and cartoned plastic commodities maintained in single-row and double-row racks can be protected by in-rack sprinklers in only the longitudinal flue space under the following conditions:

1. The ceiling and in-rack sprinkler systems are wet-pipe only, and
2. The storage racks meet the definition of open-frame, and
3. The depth (aisle-to-aisle) of the double-racks does not exceed 9 ft (2.7 m), and
4. The in-racks sprinklers are in accordance with Sections 2.3.4.1.1, 2.3.4.3, 2.3.4.4, and 2.3.4.5, and
5. The in-rack sprinklers are installed horizontally at every transverse flue space intersection as outlined in Figure 11 for single-row racks and Figure 12 for double-row racks, and
6. The in-rack sprinklers are installed on vertical increments not exceeding 12 ft (3.6 m), and
7. The storage height above the top in-rack sprinkler level does not exceed 10 ft (3.0 m), and

8. The in-rack design is based on Table 12, and
9. The ceiling design is based on Table 13, and
10. The hose stream allowance and system duration are based on Table 14.
11. Balance the ceiling-level sprinkler system water demand with the in-rack sprinkler system water demand at the point where the two systems are connected.

2.3.6.3.2 As an alternative to the protection outlined in Section 2.3.6.3.1, Class 1, 2, 3, 4 and cartoned plastic commodities maintained in single-row and double-row racks can also be protected by in-rack sprinklers in only the longitudinal flue space under the following conditions:

1. The ceiling and in-rack sprinkler systems are wet-pipe only, and
2. The storage racks meet the definition of open-frame, and
3. The depth (aisle-to-aisle) of the double-row racks does not exceed 9 ft (2.7 m), and
4. The in-rack sprinklers are quick-response and in accordance with Sections 2.3.4.1.1, 2.3.4.3, 2.3.4.4, and 2.3.4.5, and
5. The in-rack sprinklers are installed horizontally at every other transverse flue space intersection, as outlined in Figure 8 for single-row racks and Figure 9 for double-row racks, and staggered vertically, and
6. The in-rack sprinklers are installed on vertical increments not exceeding 12 ft (3.6 m), and
7. All transverse/longitudinal flue space intersections are protected with in-rack sprinklers at vertical increments not exceeding 24 ft (7.2 m), and
8. The storage height above the top in-rack sprinkler level does not exceed 10 ft (3.0 m), and
9. The in-rack design is based on Table 12, and
10. The ceiling design is based on Table 13, and
11. The hose stream allowance and system duration are based on Table 14.
12. Balance the ceiling-level sprinkler system water demand with the in-rack sprinkler system water demand at the point where the two systems are connected.

2.3.6.4 Protection of Class 1, 2, 3, 4, Cartoned Plastics and Uncartoned Unexpanded Plastics in Single and Double-Row Racks Using a Combination of Longitudinal In-Rack Sprinklers and Horizontal Barriers

Class 1, 2, 3, 4, cartoned plastic and uncartoned unexpanded plastic commodities maintained in single-row and double-row racks can be protected by in-rack sprinklers in only the longitudinal flue space under the following conditions:

1. The storage racks are not physically equipped with solid shelves, and
2. The stored products within the racks do not extend more than 3 in. (75 mm) beyond the edge of the horizontal barrier, and
3. A minimum gross 3 in. (75 mm) wide space is provided between stored product, and
4. A minimum net 3 in. (75 mm) wide space is provided horizontally at least every 10 ft (3.0 m), and
5. The depth (aisle-to-aisle) of the double-row racks does not exceed 9 ft (2.7 m), and
6. The in-rack sprinklers are quick-response and in accordance with Sections 2.3.4.1.1, 2.3.4.3, 2.3.4.4, and 2.3.4.5, and
7. The longitudinal in-rack sprinklers are installed horizontally on a maximum linear spacing of 5 ft (1.5 m), and
8. The in-rack sprinklers are installed on vertical increments not exceeding 12 ft (3.6 m), and
9. The horizontal barriers are installed in accordance with Section 2.3.4.6.1.5 and above the lowest in-rack sprinkler level as well as vertically at every other in-rack sprinkler level (i.e., first in-rack level, third in-rack level, etc.), and
10. The storage height above the top in-rack sprinkler level does not exceed 10 ft (3.0 m), and
11. The in-rack design is based on Table 12, and
12. The ceiling design is based on Table 13, and
13. The hose stream allowance and system duration are based on Table 14.
14. Balance the ceiling-level sprinkler system water demand with the in-rack sprinkler system water demand at the point where the two systems are connected.

2.3.6.5 Protection of Class 1, 2, 3, 4 Cartoned Plastics (Unexpanded and Expanded) and Uncartoned Unexpanded Plastics in Open-Frame Storage Racks Using K14.0 (K200) and Larger, Quick-Response, Pendent Ceiling-level Sprinklers for Ceiling Heights up to 45 ft (13.5 m) High

Class 1, 2, 3, 4, cartoned plastics (unexpanded and expanded) and uncartoned unexpanded plastics can be protected by a single level of in-rack sprinklers under the following conditions:

1. The ceiling-level sprinkler are quick-response, standard-coverage (does not apply to extended-coverage sprinklers), and minimum K14.0 (K200) or larger, and
2. The storage racks meet the definition of open-frame, and
3. The in-rack sprinklers are installed on a wet system only and are in accordance with Sections 2.3.4.1.1, 2.3.4.3, 2.3.4.4, and 2.3.4.5, and
4. The in-rack sprinklers are installed horizontally as follows:
 - a. Per Figure 11 for single-row racks, or
 - b. Per Figure 12 for double-row racks storing Class 1 through 4 and cartoned unexpanded plastic commodities, or
 - c. Per Figure 13 for double-row racks storing cartoned expanded and uncartoned unexpanded plastic commodities, or
 - d. Per Figure 14 (without face sprinklers) for multiple-row racks storing Class 1 through 4 and cartoned unexpanded plastic commodities, or
 - e. Per Figure 14 (with face sprinklers) for multiple-row racks storing cartoned expanded and uncartoned unexpanded plastics, and
5. The in-rack sprinklers are installed vertically at a tier height that is located within the range of one-half to two-thirds of the overall storage height, and
6. The in-rack design is based on a minimum flow of 60 gpm (230 L/min) from the most remote 8 in-rack sprinklers, and
7. The ceiling design is obtained from the protection table for the commodity hazard being protected using a ceiling height of 40 ft (12.0 m). For uncartoned unexpanded plastics being protected by either quick-response K14.0 (K200) pendent sprinklers, or quick-response K16.8 (K240) pendent sprinklers, use a ceiling design of 12 AS @ 90 psi (6.2 bar) for the K14.0 (K200) sprinkler, or a ceiling design of 12 AS @ 63 psi (4.3 bar) for the K16.8 (K240) sprinkler, and
8. The hose stream allowance and system duration are based on Table 14.
9. Balance the ceiling-level sprinkler system water demand with the in-rack sprinkler system water demand at the point where the two systems are connected.

2.3.6.6 Alternative In-Rack Sprinkler Designs

2.3.6.6.1 General

The in-rack sprinkler designs provided in this section are alternatives to the in-rack sprinkler designs recommended in Section 2.3.4 of this data sheet.

2.3.6.6.2 Occupancy

The designs in this section can be used to protect all commodities addressed in this data sheet.

Do not use the in-rack sprinkler designs in this section to protect open-top containers, unless they are located on the bottom tier level.

Storage racks must meet the guidelines for "open-frame" as outlined in Section 2.2.3.2.

2.3.6.6.3 Protection

2.3.6.6.3.1 In-Rack Sprinkler System

The alternative in-rack sprinkler designs in this section are for wet-pipe systems only.

2.3.6.6.3.2 In-Rack Sprinklers

Use FM Approved Storage (ceiling) sprinklers that are standard-coverage, quick-response, pendent, and have a nominal temperature rating of 160°F (70°C). Use minimum K22.4 (K320) sprinklers; however, minimum 14.0 (K200) sprinklers can be used when the required flow for the commodity being protected is 100 gpm (380 L/min) or less.

2.3.6.6.3.3 Horizontal Location of In-Rack Sprinklers

See Figures 19a, 19b, 19c, 20a, 20b and 21 for the recommended horizontal location of in-rack sprinklers, depending on the type of storage rack being protected. The minimum and maximum horizontal distances between in-rack sprinklers is 27 in. (700 mm) and 4.5 ft (1.4 m), respectively, except as shown in the applicable figures. The maximum horizontal distance between face sprinklers and either (1) the face of the storage rack, or (2) the outer edge of the pallet load if it protrudes into the aisle, is 18 in. (450 mm). Locate all in-rack sprinklers within the footprint of the rack structure they are intended to protect. In-rack sprinklers protecting the flue space created between a single-row rack structure and a wall located within 12 in. (300 mm) horizontally of the rack structure can be positioned outside the footprint of the single-row rack structure as shown in Figure 19c.

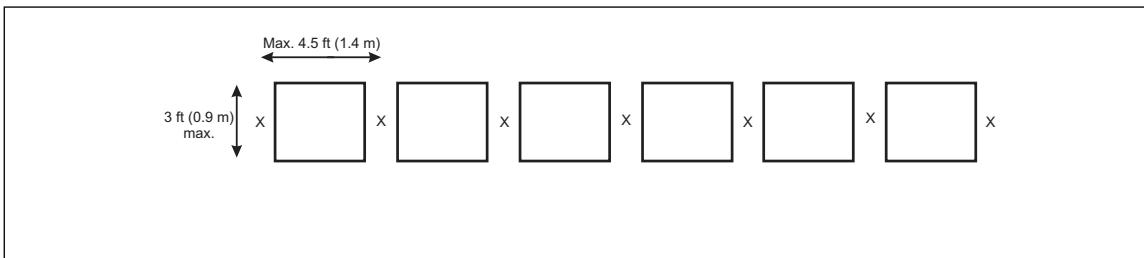

Fig. 19a. Plan view of alternative in-rack sprinkler arrangement for single-row racks up to 3 ft (0.9 m) deep

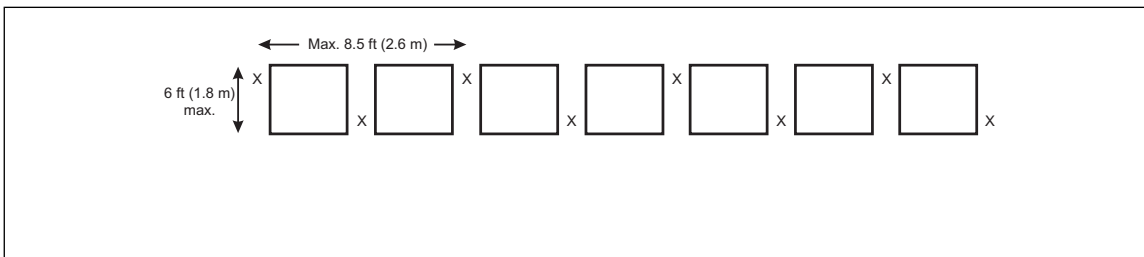

Fig. 19b. Plan view of alternative in-rack sprinkler arrangement for single-row racks up to 6 ft (1.8 m) deep

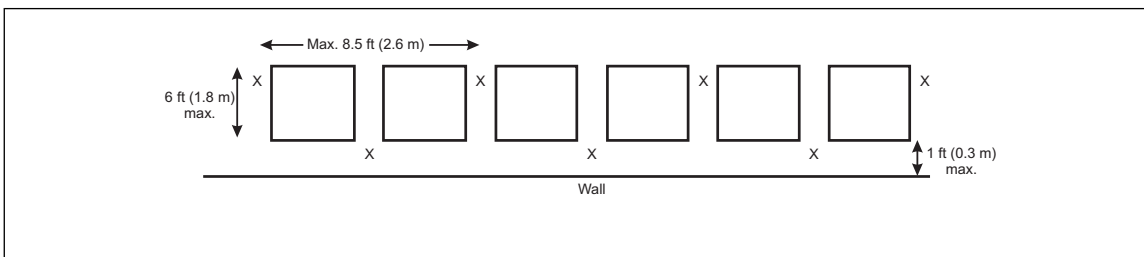

Fig. 19c. Plan view of alternative in-rack sprinkler arrangement for single-row racks up to 6 ft (1.8 m) deep located against wall

Arrange sprinkler piping and in-rack sprinklers to avoid mechanical damage, but ensure proper distribution from the in-rack sprinkler can be achieved. Prior to installing in-rack sprinklers, check the proposed in-rack sprinkler locations to ensure both adequate protection against mechanical damage and proper sprinkler discharge are provided.

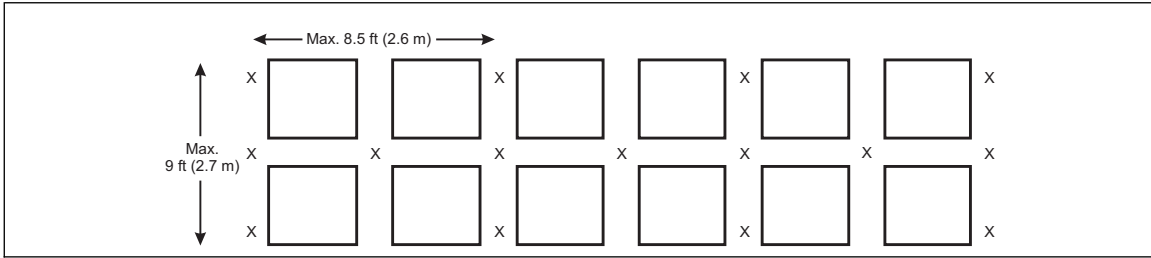

Fig. 20a. Plan view of alternative in-rack sprinkler arrangement for double-row racks up to 9 ft (2.7 m) deep

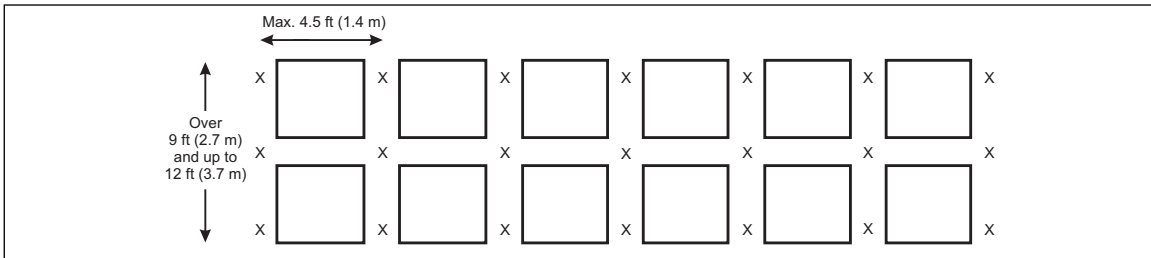

Fig. 20b. Plan view of alternative in-rack sprinkler arrangement for double-row racks up to 12 ft (3.7 m) deep

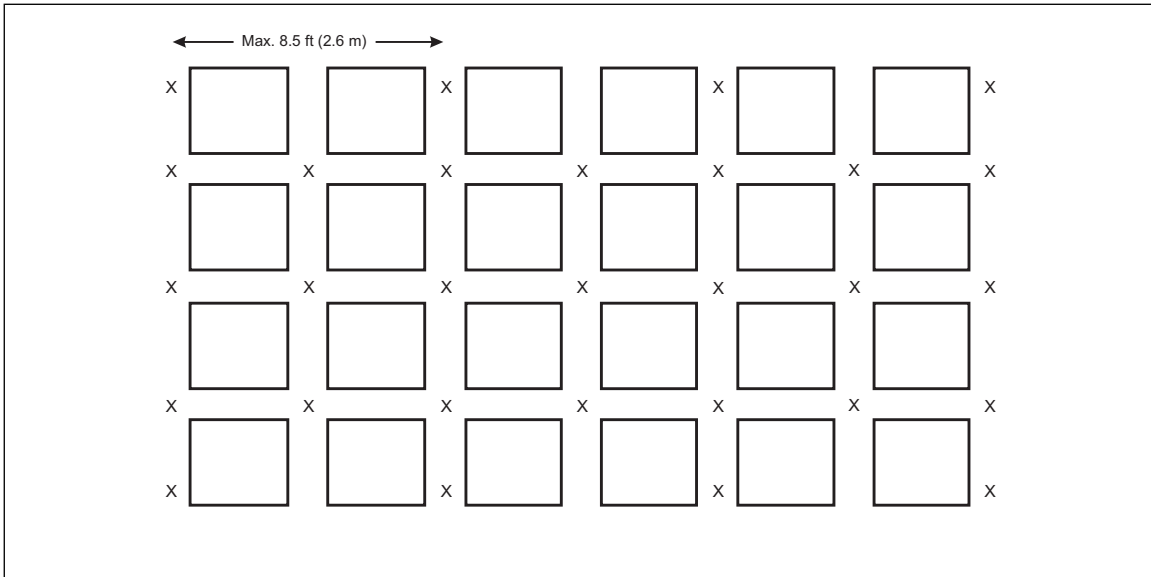

Fig. 21. Plan view of alternative in-rack sprinkler arrangement for multiple-row racks

2.3.6.6.3.4 Vertical Location of In-Rack Sprinklers

The maximum vertical distance between in-rack sprinkler levels is 30 ft (9.0 m) for cartoned expanded plastics as well as uncartoned plastics. The maximum vertical distance for Class 1 through 4 and cartoned unexpanded plastics is 40 ft (12 m). Provide a minimum vertical clearance of 6 in. (150 mm) between the top of storage and the sprinkler deflector.

At each tier level where in-rack sprinklers are needed, position the in-rack sprinkler deflector at or just below the bottom of the rack's horizontal support member when it is under full load conditions.

2.3.6.6.3.5 In-Rack Sprinkler System Design

Regardless of the number of in-rack sprinkler levels installed, design the in-rack sprinkler system for the single most hydraulically remote in-rack sprinkler tier level taking into account the minimum number of in-rack sprinklers in the design as indicated in Table 15 as well as the minimum flow from the most remote in-rack sprinkler as indicated in Table 16.

Table 15. Number of Sprinklers in the In-Rack Sprinkler System Design

| IRAS Installation Figure Used | Number of In-Rack Sprinklers in the In-Rack Sprinkler System Design | |
|--|--|------------------------------|
| | Class 1 through 4 and Cartoned Plastics and Uncartoned Unexpanded Plastics | Uncartoned Expanded Plastics |
| Single-row racks up to 3 ft (0.9 m) deep (Fig. 19a) | 4 | 4 |
| Single-row racks up to 6 ft (1.8 m) deep (Fig. 19b) | 5 | 5 |
| Single-row racks up to 6 ft (1.8 m) deep against wall (Fig. 19c) | 5 | 5 |
| Double-row racks up to 9 ft (2.7 m) deep (Fig. 20a) | 6 | 6 & 4* |
| Double-row racks up to 12 ft (3.6 m) deep (Fig. 20b) | 6 | 6 & 4* |
| Multiple-row racks (Fig. 21) | 6 | 6 & 4* |

* The number of in-rack sprinklers in the design consists of 6 in-rack sprinklers in the most remote storage rack as well as the most remote 4 in-rack sprinklers in an adjacent storage rack when the aisle width is less than 8 ft (2.4 m). If the aisle width is 8 ft (2.4 m) or greater, the design does not have to account for the 4 in-rack sprinklers in an adjacent storage rack.

Table 16. Minimum Flow in the In-Rack Design

| Max. Vertical IRAS Installation, ft (m) | Commodity Hazard | Min. K-factor | Min. Flow, from Most Remote In-Rack Sprinkler, gpm (L/min) |
|---|---|---------------|--|
| 30 (9.0) | Class 1 through 4 and Cartoned Unexpanded Plastic | 14.0 (200) | 65 (250) |
| | Cartoned Expanded Plastic | 14.0 (200) | 100 (380) |
| | Uncartoned Plastics | 22.4 (320) | 120 (455) |
| 40 (12) | Class 1 through 4 and Cartoned Unexpanded Plastic | 22.4 (320) | 120 (455) |

As part of the in-rack sprinkler system design include a hose stream allowance of 250 gpm (950 L/min) for manual extinguishment. Allow at least 100 gpm (380 L/min) for inside hose stream usage, when provided, and add the balance of the hose demand to the overall in-rack sprinkler demand at the point of connection. Arrange the water supply to provide the required in-rack sprinkler system demand and hose stream allowance (when taken from the same water supply feeding the in-rack sprinkler system) for a minimum of 60 minutes.

The water supply must be capable of providing the required design for the in-rack sprinkler system independent of the design requirements of the ceiling sprinkler system. It is not necessary to hydraulically balance the in-rack sprinkler system with the ceiling-level sprinkler system, nor account for them flowing simultaneously.

2.3.6.6.3.6 Ceiling Sprinkler System Design

Design and install the ceiling-level sprinkler system in accordance with the guidelines in Section 2.3, except as modified in this section. When the in-rack sprinkler system is designed and installed in accordance with Sections 2.3.6.6.1, 2.3.6.6.2, and 2.3.6.6.3.1 through 2.3.6.6.3.5, the ceiling sprinkler system can be designed using the applicable protection table (i.e., Tables 7 through 11, depending on the commodity hazard being protected) based on a ceiling height that is obtained by taking the vertical distance between the top level of in-rack sprinklers and the actual ceiling above. In other words, the top level of in-rack sprinklers can be considered a floor for design purposes. See Figure 22 for a visual representation of this guidance. Note that the maximum storage height of 10 ft (3.0 m) above the top level of in-rack sprinklers outlined in Section 2.3.4 does not apply to this in-rack sprinkler arrangement. When the storage above the top level of in-rack sprinklers is limited to a maximum height of 5 ft (1.5 m), the ceiling sprinkler system design can be determined as previously indicated, but using protection Tables 2 through 6, as opposed to protection Tables 7 through 11, based on the commodity hazard being protected. If no storage is to be located above the top level of in-rack sprinklers, design the ceiling sprinkler system using the minimum ceiling height indicated within the applicable protection table (see Tables 2 through 6) for the commodity hazard being protected.

The water supply must be capable of providing the required design for the ceiling sprinkler system independent of the design requirements of the in-rack sprinkler system. It is not necessary to hydraulically balance the ceiling sprinkler system with the in-rack sprinkler system, nor account for them flowing simultaneously.

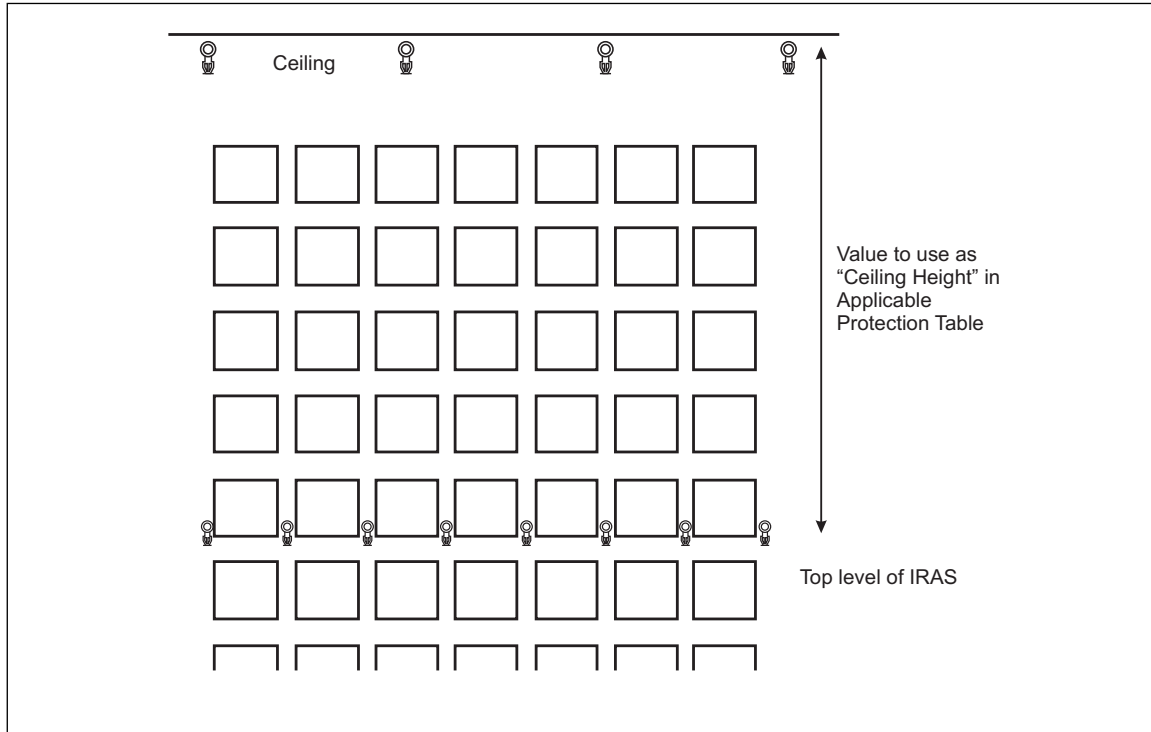

Fig. 22. Determining ceiling height in applicable protection table

2.3.6.7 Retrofit In-Rack Sprinkler Protection Solution for Uncartoned Unexpanded Plastics and Uncartoned Expanded Plastics Stored in Single-Row Racks Wider than 3 ft (0.9 m) or in Double-Row Racks Protected by In-Rack Sprinklers Installed Only in the Longitudinal Flue Space

2.3.6.7.1 General

Uncartoned unexpanded plastic commodities maintained in the following storage arrangements cannot be adequately protected by a single line of in-rack sprinklers:

- A. Open-frame single-row racks wider than 3 ft (0.9 m), or
- B. Open-frame double-row racks without horizontal barriers, or
- C. Open-frame double-row racks wider than 9 ft (2.7 m) with horizontal barriers, or
- D. Open-frame double-row racks with horizontal barriers where the commodity extends more than 3 in. (75 mm) beyond the edge of the horizontal barrier

Where uncartoned unexpanded plastics are not adequately protected by the presence of a single line of in-rack sprinklers, follow the in-rack sprinkler retrofit recommendations provided in this section.

2.3.6.7.2 Occupancy

The retrofit designs in this section can be used to protect all commodities addressed in this data sheet.

Do not use the in-rack sprinkler retrofit designs in this section to protect open-top containers unless they are located on the bottom tier level.

To use the retrofit designs in this section, storage racks must meet the guidelines for “open-frame” indicated in Section 2.2.3.2.

2.3.6.7.3 Protection

2.3.6.7.3.1 In-Rack Sprinkler System

The retrofit in-rack sprinkler designs in this section are for wet-pipe systems only.

2.3.6.7.3.2 In-Rack Sprinklers

Use FM Approved storage (ceiling) sprinklers that are standard-coverage, quick-response, pendent, minimum K22.4 (K320), and have a nominal temperature rating of 160°F (70°C).

2.3.6.7.3.3 Horizontal Location of In-Rack Sprinklers

For single-row racks more than 3 ft (0.9 m) and up to 6 ft (1.8 m) deep, remove the existing in-rack sprinklers at the tier levels where new in-rack sprinklers are recommended. See Figure 23 for a visual representation of this protection arrangement.

For double-row racks, follow the protection guidelines indicated for face sprinklers; the existing in-rack sprinklers in the longitudinal flue space do not have to be replaced. See Figure 24 for a visual representation of this protection arrangement when the storage rack is not more than 9 ft (2.7 m) deep.

The maximum recommended horizontal distance between face sprinklers and either (a) the face of the storage rack, or (b) the outer edge of the pallet load if it protrudes into the aisle, is 18 in. (450 mm). Locate all in-rack sprinklers within the footprint of the rack structure they are intended to protect. In-rack sprinklers protecting the flue space created between a single-row rack structure and a wall located within 12 in. (300 mm) horizontally of the rack structure can be positioned outside the footprint of the single-row rack structure as shown in Figure 19c.

Arrange sprinkler piping and in-rack sprinklers to avoid mechanical damage, but ensure proper distribution from the in-rack sprinkler can be achieved. Prior to installing in-rack sprinklers, check the proposed in-rack sprinkler locations to ensure both adequate protection against mechanical damage and proper sprinkler discharge are provided.

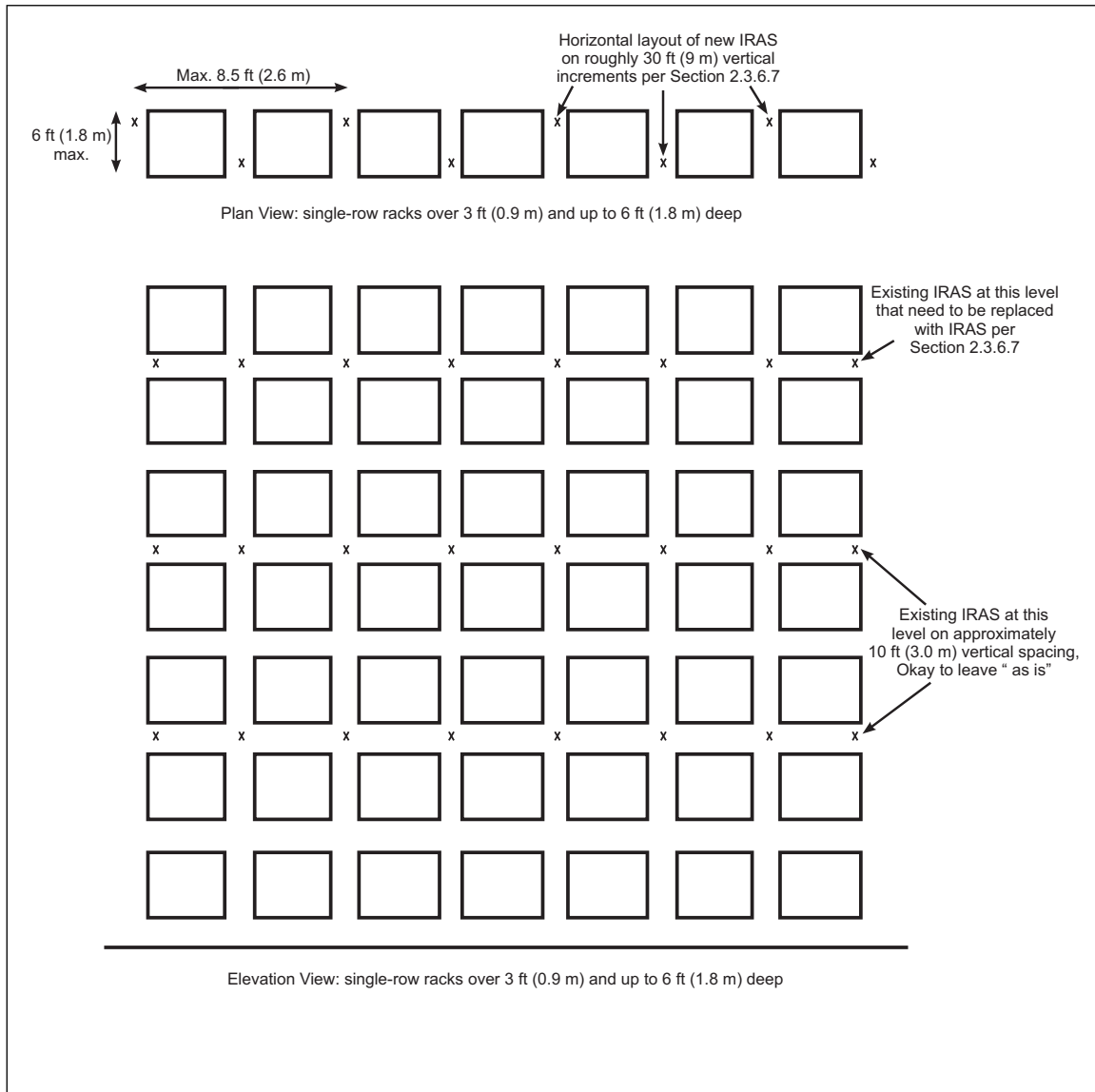

Fig. 23. Protection of uncartoned plastics in open-frame, single-row racks over 3 ft (0.9 m) and up to 6 ft (1.8 m) deep

2.3.6.7.3.4 Vertical Location of In-Rack Sprinklers

The maximum recommended vertical distance between in-rack sprinkler levels is 30 ft (9.0 m).

In addition, the maximum recommended storage height above the top level of retrofit face in-rack sprinklers is 5 ft (1.5 m). The maximum storage height above the top level of retrofit face sprinklers can be increased to 10 ft (3.0 m) when the ceiling sprinkler system can provide the design indicated per Table 13 (consider the IRAS arrangement as "IRAS(E)") for a storage height above the top level of in-rack sprinklers of "over 5 ft (1.5 m) and up to 10 ft (3.0 m)."

Provide a minimum vertical clearance of 6 in. (150 mm) between the top of storage and the sprinkler deflector. At each tier level where in-rack sprinklers are needed, position the in-rack sprinkler deflector at or just below the bottom of the rack's horizontal support member when it is under full-load conditions.

2.3.6.7.3.5 In-Rack Sprinkler System Design

Regardless of the number of in-rack sprinkler levels installed, base the in-rack sprinkler system design on the single most hydraulically remote in-rack sprinkler level. Base the minimum number of retrofit face in-rack sprinklers in the system design per Table 17.

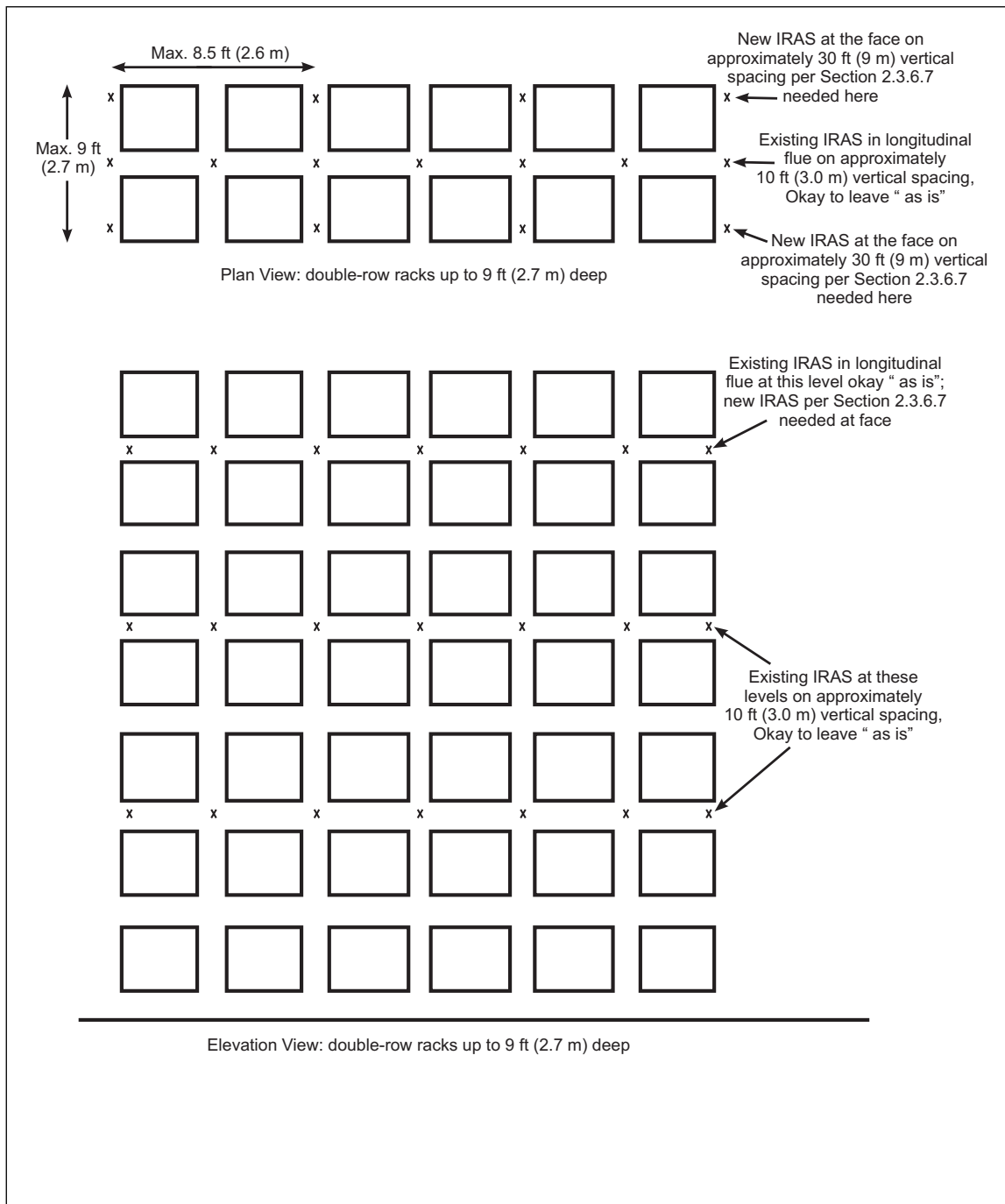

Fig. 24. Protection of uncartoned plastics in open-frame, double-row racks up to 9 ft (2.7 m) deep

Base the minimum flow required from the most remote face in-rack sprinkler on a flow of 120 gpm (455 L/min).

The retrofit in-rack sprinkler design does not need to account for any existing in-rack sprinklers flowing nor does it have to be hydraulically balanced with the existing overhead ceiling sprinkler system.

As part of the retrofit in-rack sprinkler system design, include a hose stream allowance of 250 gpm (950 L/min) for manual extinguishment. Allow at least 100 gpm (380 L/min) for inside hose stream usage, when provided, and add the balance of the hose demand to the overall retrofit in-rack sprinkler demand at the point of connection.

Arrange the water supply to provide the required retrofit in-rack sprinkler system demand and hose stream allowance (when taken from the same water supply feeding the in-rack sprinkler system) for a minimum of 60 minutes.

2.3.6.7.3.6 Ceiling Sprinkler System Design

Determine the ceiling-level sprinkler system's recommended design per Table 13 using an in-rack sprinkler arrangement (IRAS arrangement) of "IRAS(E)." If the existing ceiling-level sprinklers are K5.6 (K80) or K8.0 (K115), or if the existing ceiling-level sprinkler system is not capable of providing the indicated ceiling design for (a) a storage height of up to 5 ft (1.5 m), or (b) a storage height of over 5 ft (1.5 m) and up to 10 ft (3.0 m), then install the recommended retrofit face sprinklers above the top of storage.

Table 17. Number of Face In-Rack Sprinklers in the Retrofit In-Rack Design

| IRAS Installation Figure Used | Number of Face In-Rack Sprinklers in the Retrofit In-Rack Design | |
|--|---|---------------------------------|
| | Class 1 through 4 Cartoned Plastics and Uncartoned Unexpanded Plastics | Uncartoned Expanded Plastics |
| Single-row racks over 3 ft (0.9 m) and up to 6 ft (1.8 m) deep (Fig. 19b) | 3 | 4 |
| Single-row rack over 3 ft (0.9 m) and up to 6 ft (1.8 m) deep against wall (Fig. 19c) | 3 | 4 |
| Double-row rack up to 9 ft (2.7 m) deep (Fig. 20a) | 4 | 3 & 3 (6 total)* |
| Double-row rack over 9 ft (2.7 m) and up to 12 ft (3.6 m) deep (Fig. 20b) | 5 | 4 & 4 (8 total)* |

*The number of sprinklers indicated is based on the most remote in-rack sprinklers in both the most remote storage rack as well as the most remote adjacent sprinkler rack.

2.3.6.8 K25.2EC (K360EC) Pendent In-Rack Sprinkler Protection of Class 1, 2, 3, 4 and Cartoned Unexpanded Plastics in Open-Frame Racks in Combination with Horizontal Barriers

2.3.6.8.1 Commodity

2.3.6.8.1.1 This in-rack sprinkler protection option applies to Class 1 through 4 and cartoned unexpanded plastics only. It does not apply to cartoned expanded plastics nor any uncartoned plastics.

2.3.6.8.1.2 All storage containers must be closed top.

2.3.6.8.2 Storage Racks

2.3.6.8.2.1 Storage racks must meet the guidelines to be treated as open-frame rack storage as indicated in Section 2.2.3.2.

2.3.6.8.2.2 Arrange the storage racks so that any material overhang into the aisles is limited to a maximum of 3 in. (75 mm). If this overhang will exceed 3 in. (75 mm), see Sections 2.3.6.8.6.5 and 2.3.6.8.7.4 regarding the design requirements for both the in-rack and ceiling-level sprinkler systems.

2.3.6.8.2.3 Install horizontal barriers in accordance with Section 2.3.4.6.1.5 at every level where in-rack sprinklers are provided.

2.3.6.8.3 In-Rack Sprinkler System

The in-rack sprinkler system must be wet-pipe.

2.3.6.8.4 In-Rack Sprinklers

Install FM Approved quick-response, K25.2EC (K360EC) pendent Storage (Ceiling) sprinklers having a nominal temperature rating of either 160°F (70°C) or 212°F (100°C) under each horizontal barrier.

2.3.6.8.5 In-Rack Sprinkler Spacing and Location

2.3.6.8.5.1 Horizontal In-Rack Sprinkler Spacing and Location

2.3.6.8.5.1.1 The minimum and maximum allowable horizontal linear spacing for the in-rack sprinklers is 7 ft (2.1 m) and 8 ft 3 in. (2.5 m), respectively.

2.3.6.8.5.1.2 The minimum and maximum allowable horizontal area spacing for the in-rack sprinklers is 49 ft² (4.6 m²) and 68 ft² (6.3 m²), respectively.

2.3.6.8.5.1.3 The allowable horizontal linear spacing can be 4 ft 2 in. (1.3 m) or less when the area spacing of the in-rack sprinklers is 17.5 ft² (1.6 m²) or less.

2.3.6.8.5.1.4 Do not locate in-rack sprinklers closer than 1 ft (0.3 m) horizontally from rack uprights within single-row racks, or within double-row racks up to 9 ft (2.7 m) wide.

Exception: In-rack sprinklers can be located less than 1 ft (0.3 m) horizontally from rack uprights in either single-row racks or double-row racks up to 9 ft (2.7 m) wide when the maximum horizontal linear spacing of the in-rack sprinklers is 4 ft 2 in. (1.3 m) and the maximum area spacing is 17.5 ft² (1.6 m²).

2.3.6.8.5.1.5 Locate all in-rack sprinklers under the footprint of the horizontal barrier.

2.3.6.8.5.1.6 For single-row racks, the in-rack sprinklers may be located outside the footprint of the storage rack when all the following conditions are satisfied:

- (1) The in-rack sprinklers are located within 6 in. (150 mm) horizontally of the rack structure, and
- (2) The horizontal barrier extends outside the footprint of the rack a minimum 1 in. (25 mm) beyond the in-rack sprinklers, and
- (3) The horizontal location of the in-rack sprinklers is in accordance with Sections 2.3.6.8.5.1.1 through 2.3.6.8.5.1.3, and
- (4) The vertical location of the in-rack sprinklers is in accordance with Sections 2.3.6.8.5.2.2 and 2.3.6.8.5.2.3

2.3.6.8.5.1.7 For double-row racks, arrange the in-rack sprinklers horizontally as follows:

- (1) For a maximum rack depth of 9 ft (2.7 m), install one line of sprinklers down the center of the rack.
- (2) For a rack depth over 9 ft (2.7 m) and up to 12 ft (3.6 m), install two lines of face sprinklers, each within 18 in. (450 mm) of the rack face. Stagger the sprinklers horizontally, as needed, to meet the minimum in-rack sprinkler spacing requirements outlined in Section 2.3.6.8.5.1.1. The in-rack sprinklers do not need to be staggered if the linear spacing is in accordance with Section 2.3.6.8.5.1.3.

2.3.6.8.5.1.8 For multiple-row racks, in addition to the spacing requirements outlined in Sections 2.3.6.8.5.1.1 through 2.3.6.8.5.1.3, locate in-rack sprinklers within 18 in. (450 mm) horizontally from the face of the storage rack.

2.3.6.8.5.2 Vertical In-Rack Sprinkler Spacing and Location

2.3.6.8.5.2.1 The maximum vertical distance between in-rack sprinklers is 30 ft (9.0 m).

2.3.6.8.5.2.2 Position the in-rack sprinkler deflectors below the underside of each horizontal barrier at a vertical distance not exceeding 7 in. (175 mm).

2.3.6.8.5.2.3 The minimum vertical clearance between the top of storage and the in-rack sprinkler deflector is 9 in. (225 mm).

2.3.6.8.6 In-Rack Sprinkler System Design

2.3.6.8.6.1 In-Rack Sprinkler System Design: Minimum Required Flow

Use a minimum flow of 160 gpm (605 L/min) from the hydraulically most remote in-rack sprinkler.

2.3.6.8.6.2 In-Rack Sprinkler System Design: Minimum Number of Operating In-Rack Sprinklers

See Table 17a to determine the minimum number of in-rack sprinklers to be included in the in-rack sprinkler design. These in-rack sprinklers are all on the single most hydraulically remote tier level that is provided with in-rack sprinkler protection.

Table 17a. Minimum Number of K25.2EC (K360EC) Pendent In-Rack Sprinklers Included in the In-Rack Sprinkler Design

| Rack Type | Rack Depth, ft (m) | Aisle Width, ft (m) | No. of IRAS in Design |
|-------------------|--------------------|---------------------|--|
| Single-Row Rack | Up to 6 ft (1.8 m) | Up to 4 ft (1.2 m) | 6 total; 3 in most remote rack and 3 in nearest adjacent rack |
| | | Over 4 ft (1.2 m) | 3 in most remote rack |
| Double-Row Rack | Up to 9 ft (2.7 m) | Up to 4 ft (1.2 m) | 8 total; 4 in most remote rack and 4 in nearest adjacent rack |
| | | Over 4 ft (1.2 m) | 4 in most remote rack |
| | Over 9 ft (2.7 m) | Any | 8 total; 4 on each rack face in most remote rack |
| Multiple-Row Rack | Any | Any | 8 total; 4 along the rack face and the nearest 4 adjacent sprinklers in most remote rack |

2.3.6.8.6.3 In-Rack Sprinkler System Hose Stream Allowance and System Duration

2.3.6.8.6.3.1 As part of the in-rack sprinkler system demand include a hose stream allowance of 250 gpm (950 L/min) for manual extinguishment. Allow at least 100 gpm (380 L/min) for inside hose stream usage, when inside hose station connections are provided, and add the balance of the hose demand to the overall in-rack sprinkler system demand at the point of connection to the water supply.

2.3.6.8.6.3.2 Arrange the water supply to provide the required in-rack sprinkler system demand and hose stream allowance (when taken from the same water supply feeding the in-rack sprinkler system) for a minimum of 60 minutes.

2.3.6.8.6.4 When material overhang beyond the horizontal barrier is limited to a maximum of 3 in. (75 mm) as outlined in Section 2.3.6.8.2.2, the in-rack sprinkler system does not have to be hydraulically balanced with the ceiling-level sprinkler system, nor does it have to be added together with the ceiling-level sprinkler system design.

2.3.6.8.6.5 When material overhang beyond the horizontal barrier exceeds 3 in. (75 mm), hydraulically balance the in-rack sprinkler system and the ceiling-level sprinkler system at their point of connection.

2.3.6.8.7 Ceiling-Level Sprinkler System Design

2.3.6.8.7.1 Design and install the ceiling-level sprinkler system in accordance with the guidelines in Section 2.3, except as modified in this section.

2.3.6.8.7.2 When the in-rack sprinkler system is designed and installed in accordance with Sections 2.3.6.8.1 through 2.3.6.8.6, the ceiling-level sprinkler system can be designed using the applicable protection table (i.e., Tables 7 through 11, depending on the commodity hazard being protected) based on a ceiling height that is obtained by taking the vertical distance between the top level of in-rack sprinklers and the actual ceiling above. In other words, the top level of in-rack sprinklers can be considered a floor for design purposes. See Figure 22 of Section 2.3.6.6 for a visual representation of this guidance. Note that the maximum storage height of 10 ft (3.0 m) above the top level of in-rack sprinklers outlined in Section 2.3.4 does not apply to this in-rack sprinkler arrangement. If no storage is to be located above the top level of in-rack sprinklers, base the ceiling sprinkler system design on the minimum ceiling height indicated within the applicable protection table for the commodity hazard being protected.

2.3.6.8.7.3 When material overhang beyond the horizontal barrier is limited to a maximum of 3 in. (75 mm) as outlined in Section 2.3.6.8.2.2, the ceiling-level sprinkler system does not have to be hydraulically balanced with the in-rack sprinkler system, nor does it have to be added together with the in-rack sprinkler system design.

2.3.6.8.7.4 When material overhang beyond the horizontal barrier exceeds 3 in. (75 mm), hydraulically balance the ceiling-level sprinkler system and the in-rack sprinkler system at their point of connection.

2.3.6.9 Ceiling-Only Sprinkler Protection Recommendations for Ceiling Heights Over 40 ft (12.0 m)

2.3.6.9.1 A ceiling-only sprinkler system using quick-response, standard-coverage, 160°F (70°C) nominally rated pendent Storage sprinklers can be installed when all the conditions outlined in Table 17b have been met.

2.3.6.9.2 The ceiling sprinkler system must be wet pipe; pre-action sprinkler systems designed to meet a wet sprinkler system design do not qualify for these designs.

2.3.6.9.3 Storage racks must meet the definition of open-frame. See the guidelines in Section 2.2.3.2 to confirm that any storage racks void of solid shelves meet the requirements to be considered open-frame.

2.3.6.9.4 Commodities applicable for these designs include Class 1, 2, 3, 4 and cartoned unexpanded plastics. These designs do not apply to cartoned expanded plastics nor any uncartoned plastics (unexpanded or expanded).

2.3.6.9.5 For buildings with mineral wool or glass fiber insulation between the vertical structural supports (such as purlins), the vertical distance between the underside of the ceiling and the centerline of the sprinkler's thermal element can be measured as shown in Figure 25.

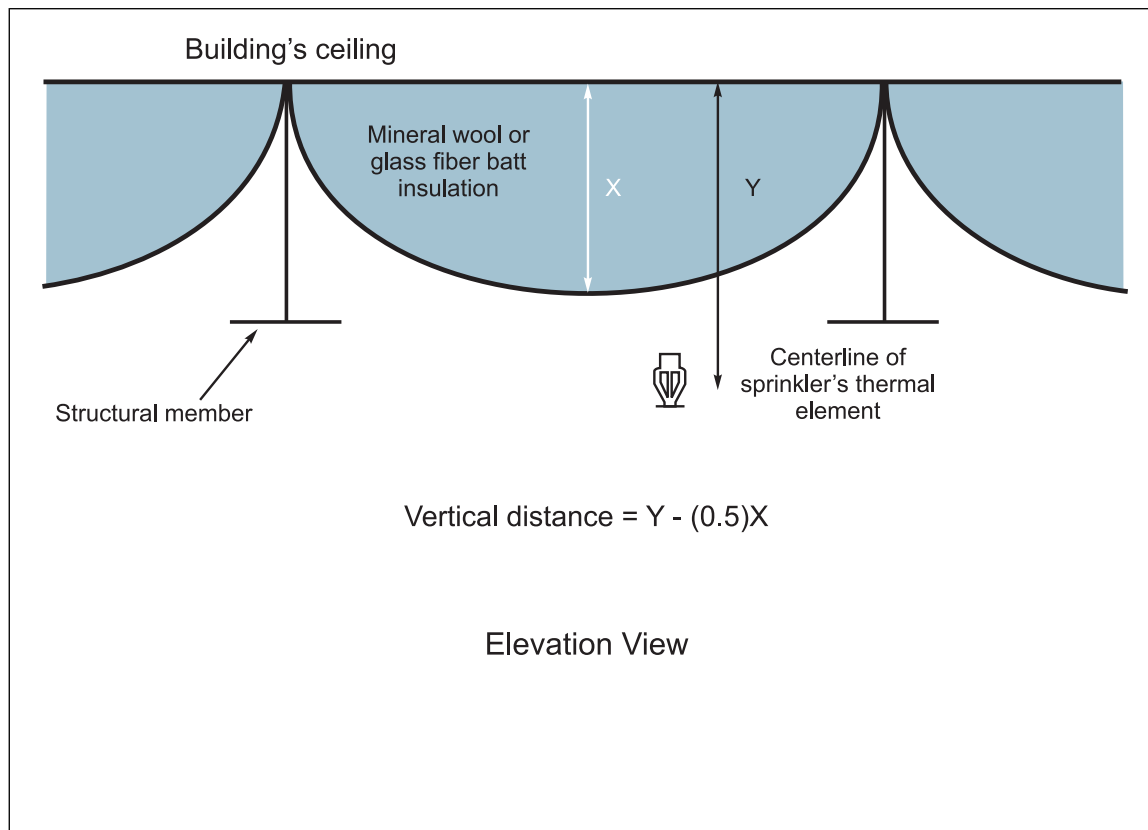

Fig. 25. Vertical distance between ceiling and centerline of sprinkler's thermal element in the presence of mineral wool or glass fiber batt insulation.

2.3.6.9.6 For ceiling sprinkler designs indicated as 9 sprinklers, base the hydraulic design on the most remote 3 sprinklers operating on the most remote 3 branchlines. For ceiling sprinkler designs indicated as 10 sprinklers, base the hydraulic design based on the following:

- a. For ceiling slopes up to 5 degrees, base the hydraulic design on the most remote 3 sprinklers operating on the most remote 3 branchlines plus 1 sprinkler operating on the most remote fourth branchline.
- b. For ceiling slopes over 5 degrees, base the hydraulic design on the most remote 4 sprinklers operating on the most remote 2 branchlines plus an additional 2 sprinklers operating on the most remote third branchline.

Table 17b. Quick-Response, 160°F (70°C) Nominally Rated, Standard-Coverage Pendent Storage Sprinkler Ceiling-Only Designs for Ceiling Heights Over 40 ft (12.0 m)

| Storage Arrangement | Commodity | Max. Storage Height, ft (m) | Max. Ceiling Height, ft (m) | Ceiling Sprinkler K-Factor | Max. Vertical Distance from Ceiling to Sprinkler's Thermal Element, in. (mm) | Min. Aisle Width, ft (m) | Sprinkler System Design | | |
|--|---|-----------------------------|-----------------------------|----------------------------|--|--------------------------|---|--------------------------|----------------------|
| | | | | | | | Ceiling Sprinkler System, No. of AS @ psi (bar) | Hose Demand, gpm (L/min) | System Duration, min |
| Solid-Piled, Palletized, Bin-Box, Shelf, and Open-Frame Racks* | Class 1, 2, 3, 4 and Cartoned Unexpanded Plastics | 45 (13.7) | 50 (15.2) | 22.4 (320) | 13 (325) | 6 (1.8) | 10 @ 63 (4.3) | 250 (950) | 60 |
| | | | | 25.2 (360) | 13 (325) | 6 (1.8) | 10 @ 50 (3.5) | | |
| | | | | | 17 (425) | 6 (1.8) | 10 @ 75 (5.2) | | |
| | | | | 28.0** (400**) | 13 (325) | 6 (1.8) | 10 @ 40 (2.8) | | |
| | | | 33.6 (480) | 6 (1.8) | 9 @ 55 (3.8) | | | | |
| | | 50 (15.2) | 55 (16.8) | 28.0 (400) | 13 (325) | 8 (2.4) | 9 @ 80 (5.5) | | |
| | | | | 33.6 (480) | 17 (425) | 6 (1.8) | 9 @ 55 (3.8) | | |

* See the guidelines in Section 2.2.3.2 to confirm that any multiple-row racks being protected in accordance with this table meet the requirements to be considered open-frame.

** The design of 10 AS @ 40 psi (2.8 bar) can be reduced to 9 AS @ 40 psi (2.8 bar) when the water supply can also provide a minimum pressure of 80 psi (5.5 bar) from the most remote 4 sprinklers (2 sprinklers on 2 lines).

2.3.6.9.7 Commodities Up to and Including Uncartoned Unexpanded Plastics: Ceiling Heights up to 45 ft (13.5 m)

Protect maximum 25 ft (7.5 m) high solid-piled, palletized, shelf, or bin-box storage of commodity hazards up to and including uncartoned unexpanded plastics maintained under a maximum ceiling height of 45 ft (13.5 m) as follows:

- A. The sprinkler system must be a wet system (pre-action sprinkler systems do not qualify).
- B. Sprinklers are quick response, 160°F (70°C) nominally rated, minimum K25.2 (K360) pendent Storage sprinklers and installed in accordance with FM Property Loss Prevention Data Sheet 2-0, *Installation Guidelines for Automatic Sprinklers*.
- C. The sprinkler design is a minimum of 12 sprinklers operating at a minimum pressure of 60 psi (4.1 bar) allowing for a hose demand of 250 gpm (950 L/min) and a sprinkler system duration of 60 minutes.

3.0 SUPPORT FOR RECOMMENDATIONS

3.1 General

The fire protection recommendations in this data sheet are based on testing, loss experience, and engineering judgment. Not every situation has been tested, nor has every potential solution been identified. Carefully consider all the variables involved when exploring options that differ from those recommended in this data sheet.

3.2 Loss History

Loss experience has shown that when there are no major automatic sprinkler system deficiencies, fires in storage occupancies are controlled by the existing sprinkler system protection arrangement. Major protection deficiencies include inadequate water supplies, closed or partially closed valves, obstructed sprinkler piping, missing sprinklers, and flammable liquid or aerosol protection deficiencies. Protection deficiencies were identified in all storage losses where the fire was uncontrolled.

Note that storage loss experience to date has involved primarily standard-response K5.6 (K80) or K8.0 (K115) sprinklers. Experience with K11.2 (K160) and larger sprinklers is limited due to their relatively recent development.

Some general deductions can be made from a study of rack storage losses (solid-piled/palletized losses have not been studied in similar detail) that occurred in a recent 18-year period, and in which no protection deficiencies were identified. These losses involve standard-response K5.6 (K80) and K8.0 (K115) sprinklers exclusively. The basic findings are as follows:

1. In-rack sprinklers, used in conjunction with ceiling-level sprinklers, are overwhelmingly successful.
2. Both the amount of damage and the number of sprinklers that open during a fire increase with higher storage / building heights.

The percentage of rack storage fires controlled by a given number of sprinklers is shown in the Table 18:

Table 18. Relationship Between the Number of Sprinklers that Operate During a Storage Fire and Fire Control

| <i>Number of Sprinklers that Operate During a Fire</i> | <i>Percentage of Fires Controlled</i> |
|--|---------------------------------------|
| 1 | 14% |
| 2 or fewer | 32% |
| 3 or fewer | 41% |
| 4 or fewer | 49% |
| 5 or fewer | 54% |
| 10 or fewer | 77% |
| 25 or fewer | 98% |

For sprinkler systems consisting of ceiling-level sprinklers only, the average number of sprinklers that opened during a storage fire was eight. For sprinkler systems consisting of the combination of ceiling-level and in-rack sprinklers, the average number of sprinklers that opened during a storage fire was three ceiling-level sprinklers and three in-rack sprinklers.

The use of hoses use was identified in 87% of the incidents that operated ten or fewer sprinklers and, when hoses were used, they were applied either before sprinklers operated or before fire control was achieved in a little more than 50% of the cases. This strong correlation suggests early application of hose streams has a significant effect on the average number of sprinklers that operate in rack storage fires (it would follow that this is also true for solid-piled / palletized storage fires), and that provision of small hose stations is a key element in the overall protection scheme. It is impossible to say how many catastrophic fires may have been prevented by early intervention using hoses.

3.3 Illustrative Losses

3.3.1 Roll Cloth in Racks Obstruct Flue Spaces, Resulting in Extensive Fire and Water Damage

At a large textile facility, 8 to 9 ft (2.4 to 2.7 m) long, encapsulated, finished roll cloth was stored in open-frame double-row racks up to 12 ft (3.7 m) high on the third floor of a warehouse.

The rolls were only one high per tier, and were packed tightly due to high production demands. This abutment of the rolls obstructed water from penetrating into the racks and only left about a 1 in. (25 mm) flue at most of the 10 ft (3.0 m) uprights. A fire started on the bottom tier and traveled down the length of the rack for 30 ft (9.0 m) in each direction before the sprinkler system achieved enough penetration to gain control of the fire. During the fire, 91 sprinklers operated, but the facility had a strong water supply with an unlimited water source. Approximately 200 rolls of cloth were damaged by fire, and all other rolls of cloth and finished goods in the area were damaged by smoke and water to various degrees. There was extensive water damage to finished goods stored in a basement area in an adjoining building with wooden intermediate floors.

3.3.2 Many Loss Prevention Principles Compromised in Warehouse Fire

Temporary aisle storage of palletized plastic automobile consoles, portable racked steel core steering wheels with polyurethane foam padding and PVC skin, and palletized motor oil were introduced into an automotive parts and accessories warehouse. In most areas of the warehouse, portable racks were stacked six high to a total height of about 20 ft (6.0 m). Permanent racks were 10 ft (3.0 m) high and usually had another 10

ft (3.0 m) of baskets stacked on top. The ceiling-level sprinkler system was only capable of protecting these commodities in the indicated storage arrangements to a maximum height of 5 ft (1.5 m) based on the available water supply.

A fire, probably caused by smoking, resulted in the largest loss FM had investigated up to that time. The storage was too high, the sprinkler water application was too low, sprinkler orifice sizes and temperature ratings were incorrect, temporary storage blocked the aisles, and there were no flue spaces.

3.3.3 Inadequate Sprinkler Protection Unable to Control Fire Involving Aisle Storage and Racks with Solid Shelves

Clothing and shoes were stored in single-row racks from 22 to 26 ft (6.6 to 7.9 m) high. Idle pallets up to 12 ft (3.7 m) high were stored in 6 ft (1.8 m) wide aisles between racks. Solid shelves were present in the lower two tiers to form picking bins. In-rack sprinklers were not provided. A fire starting in this area overtaxed the ceiling-level sprinkler system. Roof collapse occurred within 20 minutes of fire discovery. Approximately 200,000 ft² (18,500 m²) of this building was destroyed.

3.3.4 Fire in High Rack-Storage Controlled by In-Rack Sprinklers

Fire in clothing stored in cartons on 16-tier, 39 ft (11.9 m) high racks was well controlled by four in-rack sprinklers and one ceiling-level sprinkler. In-rack sprinklers were provided at four levels. Complete extinguishment was provided via two small hoses.

3.3.5 Lack of In-Rack Sprinklers for Racks With Solid Shelves Results in Extensive Fire Damage

Upholstered furniture was stored on cantilever racks to 15 ft (4.5 m) high. Racks were 8 ft (2.4 m) deep and equipped with 56 ft² (5.2 m²) solid plywood shelves. In-rack sprinklers were not provided. A fire starting in the rack storage quickly overtaxed ceiling-level sprinklers, with initial roof collapse occurring within 20 minutes of fire discovery. Approximately half of the 202 by 405 ft (60 by 120 m) building's roof collapsed and storage burned. Roof collapse remote from the point of fire origin apparently hindered further horizontal fire spread by blocking flames from reaching uninvolved areas.

3.3.6 Open-Top Containers in Racks Interfere with Sprinkler Water Penetration Resulting in Uncontrolled Fire

Synthetic fiber socks were stored in open-top cardboard "tote boxes" in racks 16 ft (4.8 m) high. There were eight levels of boxes supported on metal angles in each rack. A fire started in or near the racks and water from ceiling-level sprinklers collected in boxes on the top tier levels, preventing adequate sprinkler water from penetrating through the racks to control the fire. A 390 by 530 ft (120 by 160 m) portion of the facility was destroyed. In-rack sprinklers were provided when the facility was rebuilt.

3.3.7 Poor Housekeeping Leads to Excessive Fire Spread

Solid-pile storage of 10 ft (3.0 m) high rolled and baled synthetic greige goods in burlap wrapping (a Class IV commodity) was located in a one-story, 6800 ft² (630 m²) section of a warehouse. There was 4 ft (1.2 m) clearance to ceiling sprinklers. Protection was by a dry-pipe sprinkler system with 100 ft² (9.0 m²) spacing using K5.6 (K80), 160°F (70°F) nominally rated ceiling-level sprinklers. The system was supplied by public water and a manually started fire pump rated at 1000 gpm (3800 L/min) at 100 psi (6.9 bar), capable of delivering a minimum pressure of 8 psi (0.6 bar) to the most remote 30 sprinklers, without supplying mill use or hose streams.

The plant engineer noted a rapidly spreading fire in lint accumulations in the corner of the warehouse near a baling machine. The emergency response team (ERT) and public fire service responded within ten minutes. The fire was controlled by 68 operating sprinklers and extinguished within one hour when ceiling-level sprinklers were supplemented by one large and three small hose streams. Approximately 150 bales and 200 rolls of greige goods were wet by the sprinkler system. Wood building walls and roof were scorched and charred.

Weak water supplies (water supplies to sprinklers were depleted by mill use and hose streams) and lint accumulations combined to permit excessive fire development. The manual fire pump was not started for fear of contaminating mill-use water supplies.

3.3.8 Strong Water Supply Overcomes Plugged Sprinklers

Palletized storage of 12 ft (3.7 m) high, cartoned paperboard flats (a Class 3 commodity) with 4 ft (1.2 m) clearance to ceiling-level sprinklers was in a one-story warehouse. Protection was provided by a dry-pipe sprinkler system with 64 ft² (6.0 m²) spacing with K5.6 (K80), 280°F (140°C) nominally rated ceiling-level sprinklers. The system was supplied by an automatic fire pump rated at 1500 gpm (5700 L/min) at 100 psi (6.9 bar) and capable of providing a minimum pressure of 93 psi (6.4 bar) over the most remote 38 sprinklers on 64 ft² (6.0 m²) spacing.

The public fire service was notified of the storage fire 30 minutes after the alarm and achieved extinguishment within one hour, using three small hoses. A total of 20 ceiling-level sprinklers opened and controlled limiting the damage to 30 pallet loads of cartoned paperboard flats and 250 ft² (23 m²) of charred ceiling.

An investigation of the 20 sprinklers that opened during the fire indicated that 10 of them were plugged with stones. The remaining 10 operating sprinklers were able to limit the fire spread in large part because the existing water supplies were able to provide well in excess of the normal recommended water application for the array and product.

4.0 REFERENCES

4.1 FM

Data Sheet 1-2, *Earthquakes*

Data Sheet 1-10, *Interaction of Sprinklers, Smoke and Heat Vents, and Draft Curtains*

Data Sheet 1-12, *Ceilings and Concealed Spaces*

Data Sheet 1-24, *Protection Against Liquid Damage*

Data Sheet 2-0, *Installation Guidelines for Automatic Sprinklers*

Data Sheet 2-8, *Earthquake Protection for Water-Based Fire Protection Systems*

Data Sheet 5-48 *Automatic Fire Detection*

Data Sheet 7-29, *Ignitable Liquid Storage in Portable Containers*

Data Sheet 8-1, *Commodity Classification*

Data Sheet 8-24, *Idle Pallet Storage*

APPENDIX A GLOSSARY OF TERMS

Aisle: A clear space maintained between commodities stored either in racks or on the floor.

Approval Guide: An online resource of FM Approvals that provides a guide to equipment, materials, and services that have been FM Approved for property conservation.

Bin-Box Storage: A storage arrangement that typically consists of solid shelves in combination with solid full-height wooden or metal vertical barriers. There is usually a solid backing for each bin-box storage unit, but this is not always the case. While this type of storage arrangement typically shields direct water application to the burning commodity maintained within each bin-box storage unit, the relatively low tier height between solid shelves coupled with the full-height vertical barriers help to reduce the heat release rate of the fire as well as severely delay its potential for horizontal fire growth.

Clearance: The clear space maintained between the top of storage and the deflector of the sprinkler (ceiling or in-rack) located above it.

Commodity: and material handling aids (e.g., pallets). Data Sheet 8-1, *Commodity Classification*, contains commodity classification guidelines that are applicable to this data sheet. The purpose of assigning a commodity classification is to allow specification of the proper level of fire protection. A commodity classification is dependent on how the product burns and how the burning product responds to the application of sprinkler discharge. Protection specifications in this data sheet are based on the following categories of commodity:

- Class 1, Class 2, and Class 3 commodity hazards
- Class 4 commodity hazards and Cartoned Unexpanded Plastics
- Cartoned Expanded Plastics
- Uncartoned Unexpanded Plastics
- Uncartoned Expanded Plastics

Duration or System Duration: Water supply system duration is a defined time period between when a fire initially activates a sprinkler system and when the fire is extinguished. Fire extinguishment usually is accomplished by the manual firefighting efforts of public fire service personnel, facility fire service personnel, or facility emergency response team personnel applying hose streams directly onto the surfaces of the burning commodity. Duration takes into consideration the commodity hazard's expected fire size in the presence of the system's specific sprinklers, as well as manual fire extinguishment by either one or two applied hose streams.

Encapsulation: A method of packaging consisting of a plastic sheet completely enclosing the sides and top of a pallet load containing a combustible commodity or a group of combustible commodities or combustible packages. Totally noncombustible commodities on wood pallets enclosed only by a plastic sheet as described above are not considered to be encapsulated. The term "encapsulation" also applies to individual cartons that are enclosed on the top and sides in plastic, and to cartons waterproofed by coatings on the exterior surfaces.

The term "encapsulation" does not apply to individual plastic enclosed items inside a larger non-plastic enclosed or non-waterproofed container. If holes or voids in the plastic or waterproof cover on the top of the carton exceed more than half the area of the top, the term "encapsulation" does not apply.

The protection design guidelines provided in this data sheet account for the presence of encapsulation and do not need to be adjusted.

Fire Protection Scheme 8-9A: A specific fire protection scheme that uses both horizontal barriers and quick-response in-rack sprinklers to protect high-challenge commodities that would otherwise (1) require a significantly higher ceiling-level design and/or water supply to protect it, or (2) require in-rack sprinklers whereas a ceiling-only option is available for the other commodity hazards maintained within the storage area, or (3) require a higher number of in-rack sprinkler tier levels when compared to the number of tier levels required for the other commodity hazards maintained within the storage area.

By segregating the high-challenge commodities into a designated storage rack (or racks) that is equipped with Fire Protection Scheme 8-9A (i.e., Scheme 8-9A) protection, the sprinkler design for the storage area can then be based on the requirements for the highest commodity hazard not being protected by Scheme 8-9A protection. This protection scheme in essence treats the high-challenge commodities as if they have been removed from the storage area.

With Scheme 8-9A protection, the in-rack sprinkler system design is independent of the ceiling-level sprinkler system and does not have to be hydraulically balanced with it.

For example, the majority of a proposed 40 ft (12.0 m) high warehouse will contain commodity hazards ranging up to and including cartoned unexpanded plastics; however, it will also contain a small but significant amount of uncartoned expanded plastics. The existing water supply has the flow and pressure needed to support several ceiling-only protection options for cartoned unexpanded plastics; however, it is not sufficient to support any ceiling-only protection options for uncartoned expanded plastics. By segregating all of the uncartoned expanded plastics into a storage rack that is equipped with Scheme 8-9A protection, the ceiling-level sprinkler system can be designed based on the next highest commodity hazard; in this case cartoned unexpanded plastics.

This protection option can also be used at existing locations when new high-challenge commodity hazards are going to be introduced into a warehouse area where the existing ceiling-level sprinkler system does not have a sufficient design for the new high-challenge commodities.

Note that there are other options that involve the segregation of the high-challenge commodities into dedicated storage racks and protected by in-rack sprinklers that can be considered. Most of these options will be less stringent than the requirements outlined for Scheme 8-9A; the difference however is that with Scheme 8-9A protection the in-rack sprinkler system does not have to be hydraulically balanced with the ceiling-level sprinkler system. All options should be considered to determine which option works best for the specific conditions found at the storage location.

FM Approved: References to "FM Approved" in this data sheet mean the product or service has satisfied the criteria for FM Approval. Refer to the *Approval Guide* for a complete listing of products and services that are FM Approved.

Flue Spaces: The spaces between rows of storage. In rack storage, the longitudinal flue spaces are perpendicular to the direction of loading, and transverse flue spaces are parallel to the direction of loading

(Fig. A-1). Flue spaces that are less than a net 3 in. (75 mm) wide are not considered flue spaces for fire protection purposes. In addition, any space between rows of storage that exceeds 24 in. (600 mm) horizontally is considered a space that is too wide in which to install in-rack sprinklers. Flue spaces within storage configurations that are arranged as outlined in this data sheet will promptly vent heat from a fire vertically. This allows for (1) the sprinklers to operate as quickly as possible, and (2) reduced horizontal fire spread within the storage array. Flue spaces arranged as outlined in this data sheet will also allow sprinkler water penetration down through the storage arrangement. Without sufficient water penetration to burning commodities throughout the storage array, fire control may not be achieved.

Flue Space Net Width: The gross width of a flue space minus any horizontal or angled objects located within the flue space.

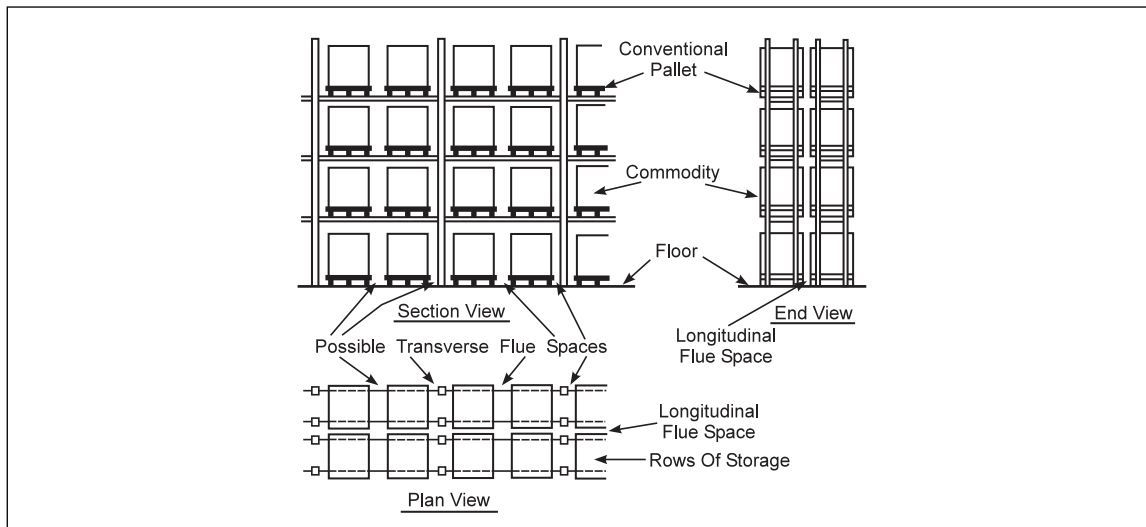

Fig. A-1. Typical double-row (back-to-back) rack arrangement

Horizontal Barriers: A solid barrier installed on a horizontal plane within a rack, beneath which in-rack sprinklers are installed. Their purpose is to impede vertical fire spread by blocking off normally open flue spaces, while also helping to achieve prompt in-rack sprinkler operation by banking heat down to the in-rack sprinklers that must be installed under each barrier.

In-Rack Sprinklers: Sprinklers that are installed within the footprint of a storage rack to provide fire control (balanced with ceiling sprinkler system) or fire suppression (not balanced with ceiling sprinkler system).

Inspector's Test Connection: A device consisting of a manual control valve, a section of sprinkler piping (allowing discharge to a safe location), and at least one smooth-bore corrosion-resistant orifice (no larger than the smallest orifice of any sprinkler installed on the sprinkler system that the inspector's test connection serves). It is used to test the waterflow alarm mechanism provided for the sprinkler system as well as determine the water delivery time for a dry or similar type of sprinkler system. It is typically installed at the hydraulically remote end of a sprinkler system.

K-factor: Also known as the discharge coefficient, it is a numerical value representing the orifice size of the sprinkler in combination with the expected flow through the sprinkler orifice at a given pressure value. It is calculated using the following equation:

$$K = \frac{Q}{\sqrt{P}}$$

Where: Q is the flow through the sprinkler orifice in gpm (L/min).
P is the pressure at the sprinkler orifice in psi (bar).
The units for K are gpm/psi^{0.5} ([L/min]/bar^{0.5}).

See Table 1 for K-factor values of Storage sprinklers that are currently FM Approved.

Movable Racks: Movable racks are on fixed rails or guides and are designed to use as much of the available storage space as possible. They can be moved in one direction only in a horizontal two-dimensional plane.

A moving aisle is created as abutting racks are loaded or unloaded, then moved across the aisle to abut other racks. Movable rack arrangements generally result in the same protection needs as those for multiple-row racks.

Nominal Temperature Rating: An indicated temperature rating that represents a given range applicable for the conditions the sprinkler is to be used for. This data sheet recommends sprinklers having nominal temperature ratings of 160°F (70°C), 212°F (100°C) or 280°F (140°C). The following indicates the ranges these nominal temperature ratings represent:

| <i>Nominal Temperature Rating, °F (°C)</i> | <i>Actual Temperature Range, °F (°C)</i> |
|--|--|
| 160 (70) | 155 (68) - 165 (74) |
| 212 (100) | 200 (93) - 220 (104) |
| 280 (140) | 280 (138) - 286 (141) |

Occupancy-Specific Data Sheet: An FM property loss prevention data sheet that addresses a specific occupancy hazard. Individual data sheets belong to a numbered "series" representing the following subjects:

| <i>Series Number</i> | <i>Data Sheet Subject</i> |
|----------------------|--|
| 1 | Construction |
| 2 | Sprinklers |
| 3 | Water supply |
| 4 | Extinguishing equipment |
| 5 | Electrical |
| 6 | Boilers and industrial heating equipment |
| 7 | Hazards |
| 8 | Storage |
| 9 | Miscellaneous |
| 10 | Human factor |
| 11 | Systems instrumentation and control |
| 12 | Pressure vessels |
| 13 | Mechanical |
| 15 | Welding |
| 17 | Boiler and machinery miscellaneous |

Open-Frame Rack Storage: Rack storage that is void of any solid shelves within the storage array and has adequate flue spaces in accordance with Section 2.2.3 to (1) allow rapid vertical fire growth (minimizing horizontal fire spread), and (2) allow downward sprinkler water penetration throughout the height of the rack. Unless indicated otherwise in this data sheet open-frame rack storage allows water discharge to reach all vertical surfaces of a commodity.

The storage racks can also be provided with minimum 70% uniformly open grated shelves with fixed-in-place solid slats as long as adequate flue spaces per Section 2.2.3 are provided

If rack storage does not meet the guidelines provided in Section 2.2.3, then it must be treated as if it has solid shelves. See the definition of solid shelving in this appendix.

Open-Top Containers: These are containers having at least one solid side, and open on top. Containers that have five sides will collect and hold up water that has been discharged from operating ceiling-level sprinklers thus delaying the water delivery down through the flue spaces where it is needed to either suppress or control the fire. Containers with less than five full-height sides redirect the discharged water from operating sprinklers so that the water delivery down through the flues is not uniform. Five-sided, open-top containers made of wood, cardboard, plastic, or other combustible material promote faster horizontal fire spread compared to closed-top combustible containers. Noncombustible open-top containers help promote faster horizontal fire spread if combustible containers are located below them within a storage rack. See Section 2.2.4 when open-top containers are present within a storage rack arrangement.

Palletized Storage: A storage arrangement that consists of product stored on pallets. Pallet loads are placed one on top of another with the bottom load located directly on the floor.

Pallets: Material handling aids upon which unit loads of commodity are placed to ease the transport of commodity from place to place (see Figure A-2). Pallets may be wood, metal, or plastic. Conventional pallets have stringers to accommodate lift trucks for handling unit loads. Slave pallets (less than 20 ft² [2.0 m²]) are special flat-bottomed pallets captive to a material handling system. See Data Sheet 8-1, *Commodity Classification*, to determine their impact on the commodity hazard rating, as well as Data Sheet 8-24, *Idle Pallet Storage*, for their required protection if they are being stored within the facility.

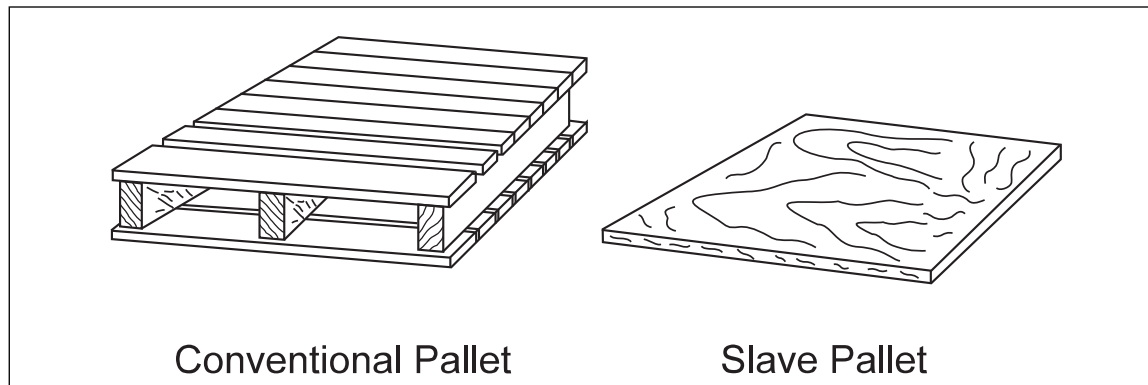

Fig. A-2. Typical wooden pallets

Portable Racks: Portable racks are not fixed-in-place. They can be arranged in any number of configurations, and include wire baskets without solid sides and bottoms and open-top containers without solid sides but with solid bottoms. Five-sided open-top combustible containers with solid sides and bottoms are treated as open-top combustible containers. Portable racks are designed to be transported with fork-lift trucks. They are typically found to have wire mesh siding with solid bottoms; however, they can be arranged in various configurations of solid or non-solid sides and bottoms. If the portable racks are not provided with proper flue spaces between them (or with another means of allowing heat from a fire to vent vertically while at the same time water from sprinklers to penetrate down through them), fire control will not be possible.

Rack Storage: Storage in racks that use combinations of vertical, horizontal and diagonal members, with or without solid shelves, to support stored material. Racks may be fixed-in-place or portable. Loading may be either conducted manually by using lift trucks, stacker cranes, or hand placement, or automatically by using machine-controlled storage and retrieval systems.

- Single-row racks are up to 6 ft (1.8 m) deep, as defined by minimum 4 ft (1.2 m) wide aisles, and typically do not have longitudinal flue spaces.
- Double-row racks are up to 12 ft (3.6 m) deep, as defined by minimum 4 ft (1.2 m) aisles, and typically have longitudinal flue spaces.
- Multiple-row racks are racks that do not meet the definition of single-row or double-row racks. Multiple-row racks can be drive-in, drive-through, flow-through, push-back or double-deep standard racks. The rack depth of more than 12 ft (3.6 m) is the determinant.

Figures A-3 through A-11 show typical rack storage configurations.

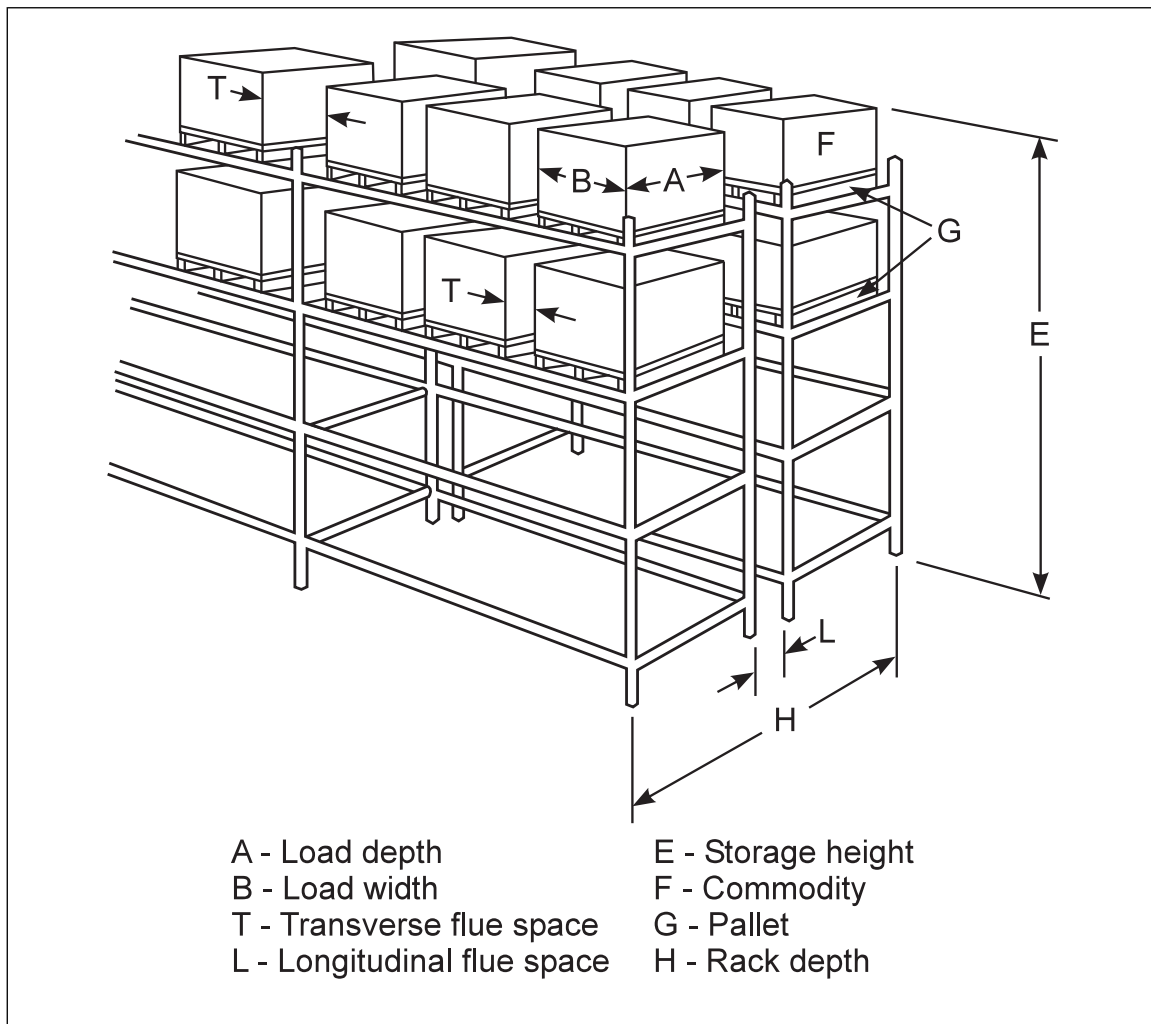

Fig. A-3. Open-frame double-row racks

Shelf Storage: Storage on a structure where solid shelves are less than 30 in. (0.8 m) deep, measured from aisle to aisle, and usually less than 2 ft (0.6 m) apart vertically.

Shuttle-type automatic storage and retrieval system: A storage arrangement using automatically operated robots that load and unload containers in a horizontal manner on a rack structure equipped with flat horizontal slats that support the container. What differentiates these storage arrangements from standard open-frame racks is (1) containers, typically 18 in. x 24 in. x 12 in. tall (450 mm x 600 mm x 300 mm tall), are stored within the racks instead of pallet loads, (2) open transverse flue spaces are maintained between each container, and (3) the tier heights are typically only 1 to 2 ft (0.3 to 0.6 m) tall.

Solid-Piled Storage: On-floor storage, without pallets or other material handling devices. Unit loads are placed on top of each other, leaving no horizontal spaces between unit loads.

Solid Shelving: Fixed-in-place, solid, slatted (fixed or non-fixed), grated (less than 70% open), or other types of shelves located within racks.

Solid shelving within storage racks can promote horizontal fire spread and negatively impact the amount of sprinkler water that can reach the entire vertical height of the rack.

See Section 2.2.3.2 to determine whether a rack equipped with solid shelving can be considered open-frame for sprinkler system design purposes or if it must be treated as a rack with solid shelves.

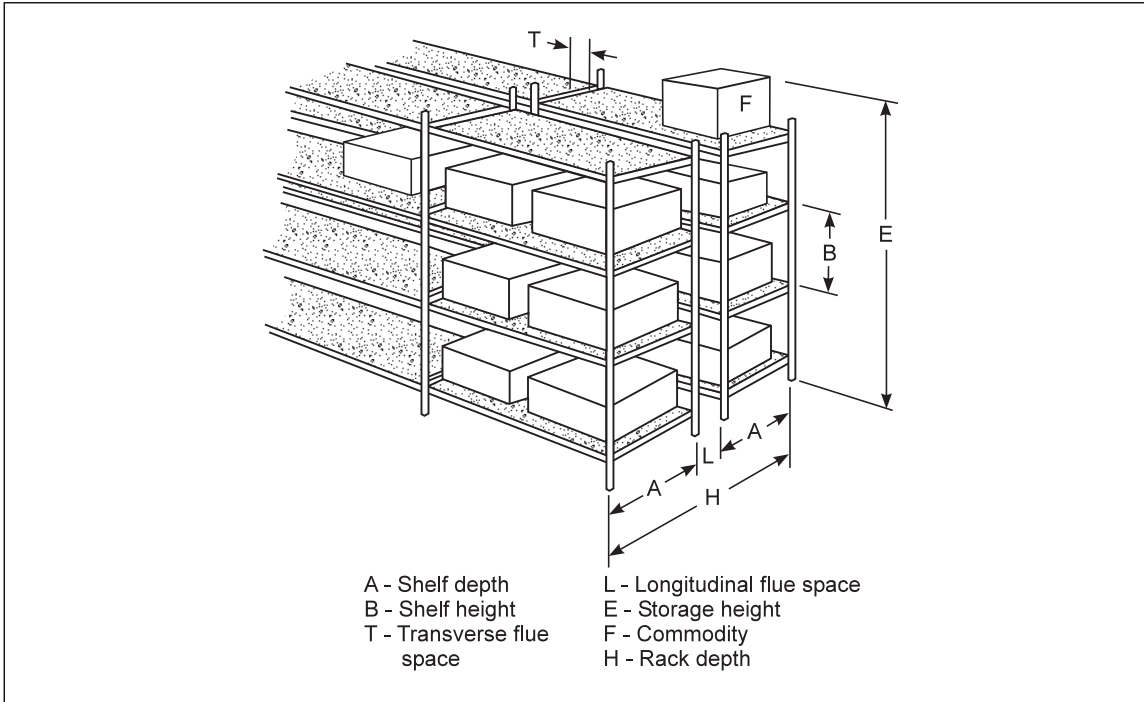

Fig. A-4. Double-row racks with solid shelves

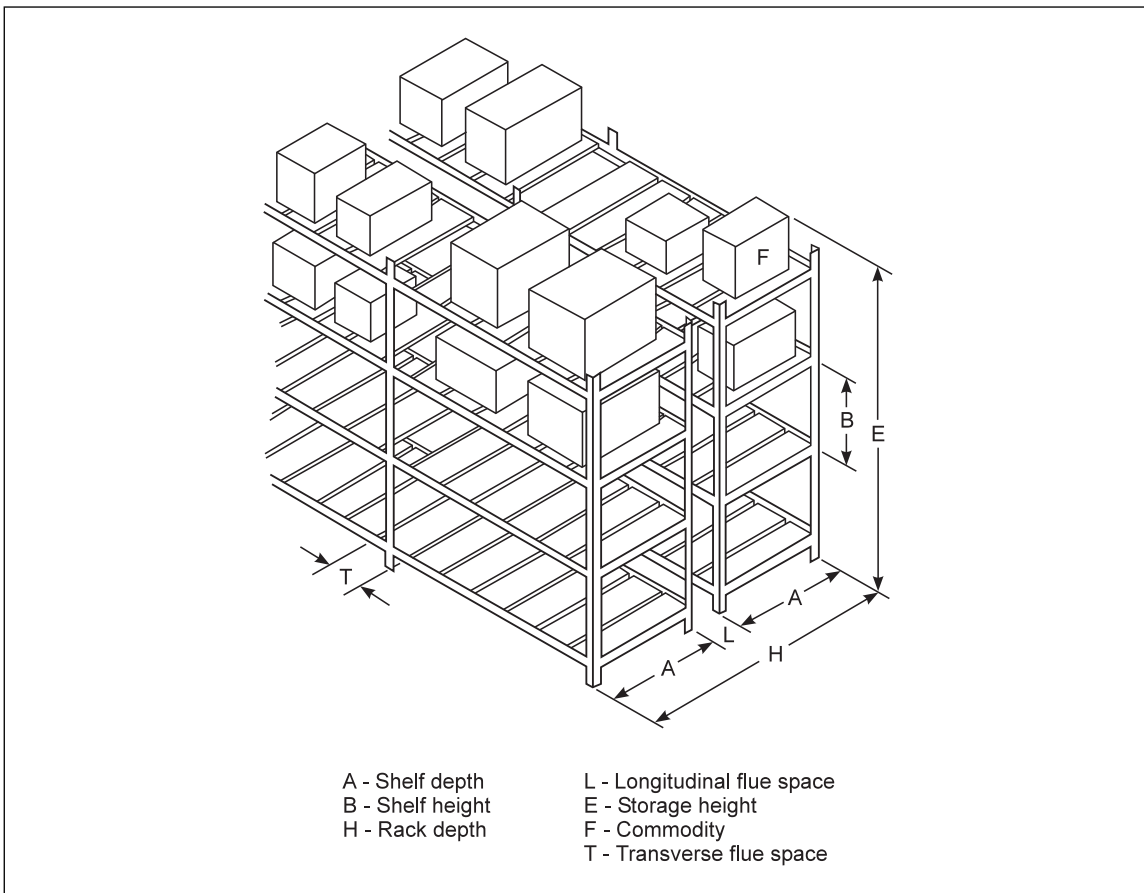

Fig. A-5. Double-row racks with slatted shelves

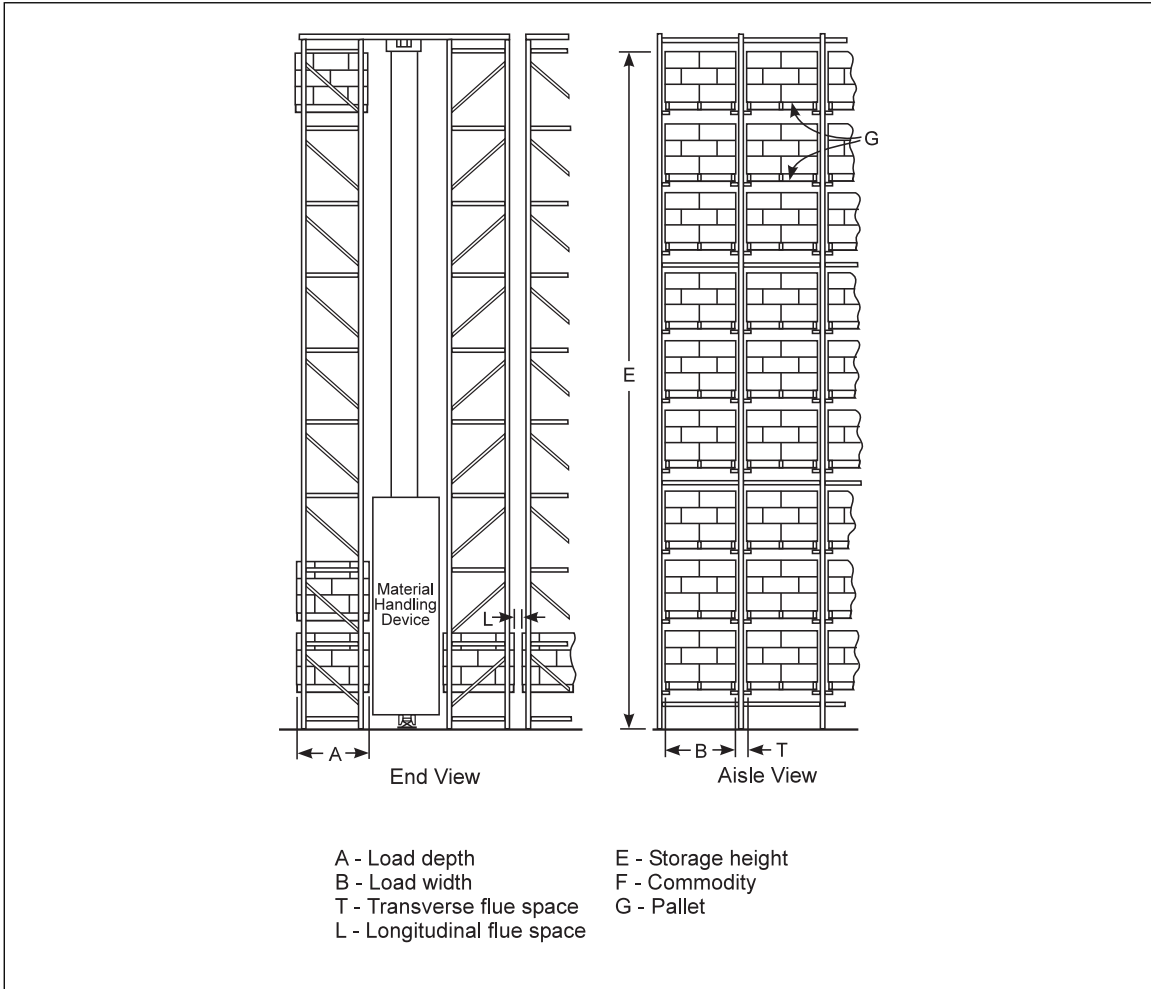

Fig. A-6. Automatic storage rack

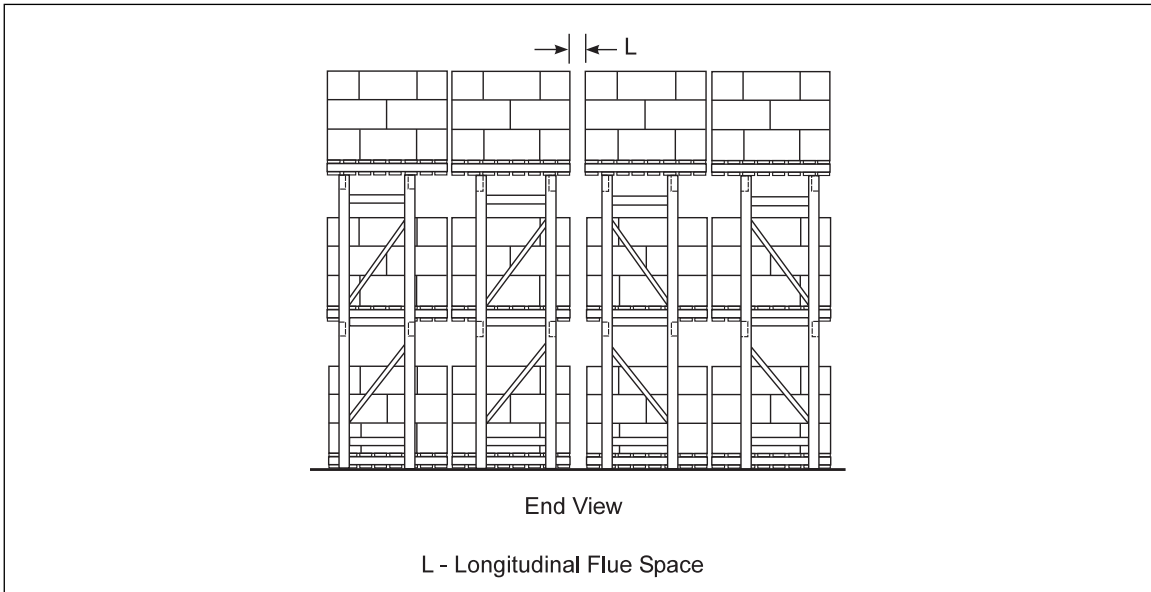

Fig. A-7. Multiple-row rack

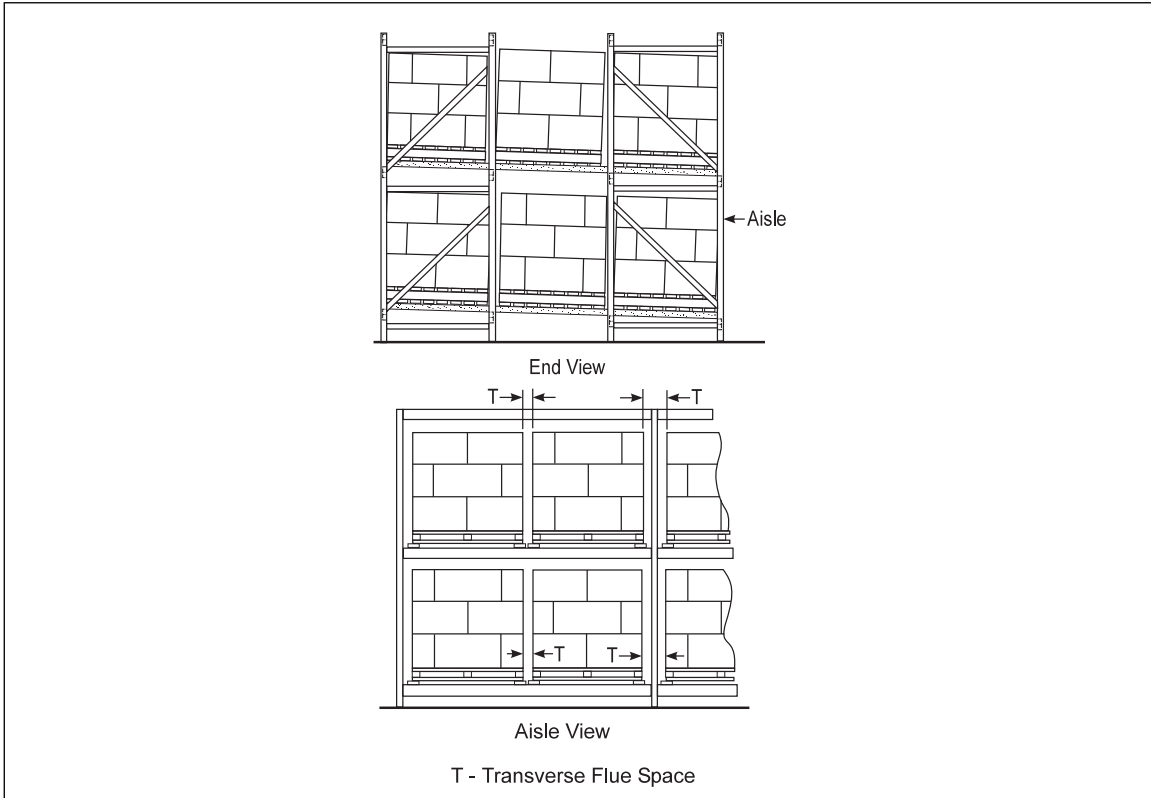

Fig. A-8. Flow-through pallet rack

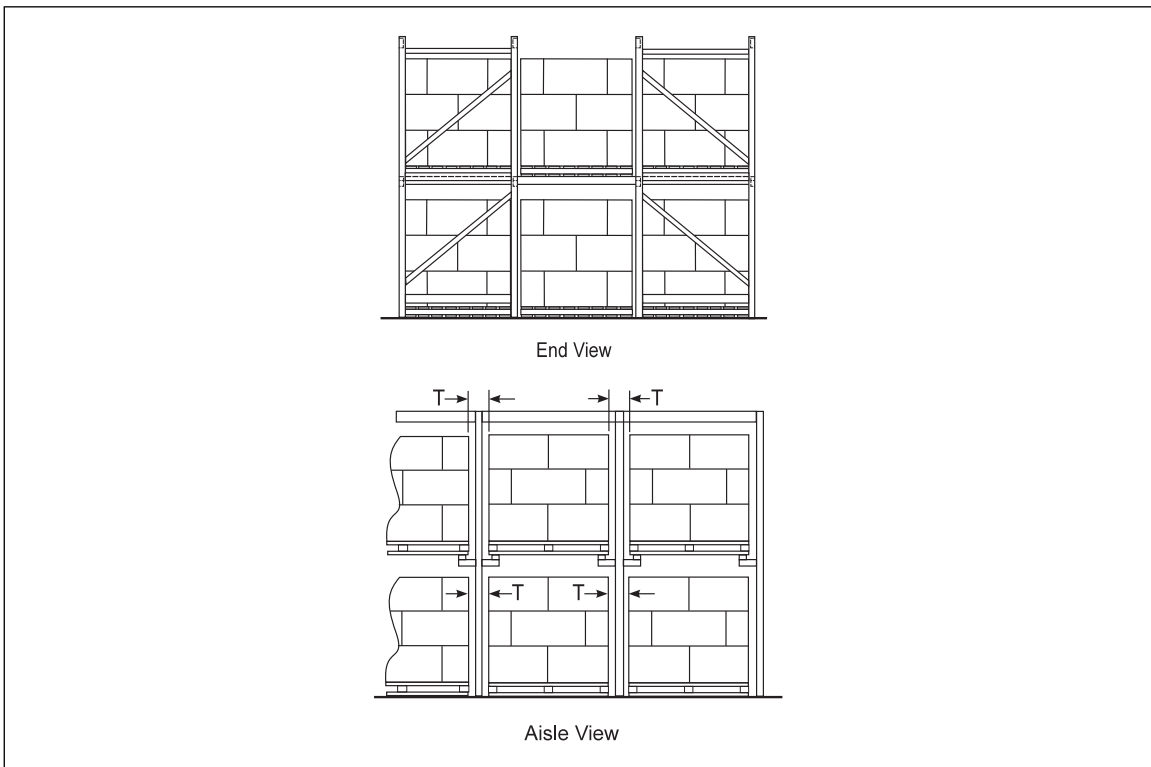

Fig. A-9. Drive-in rack, two or more pallets deep

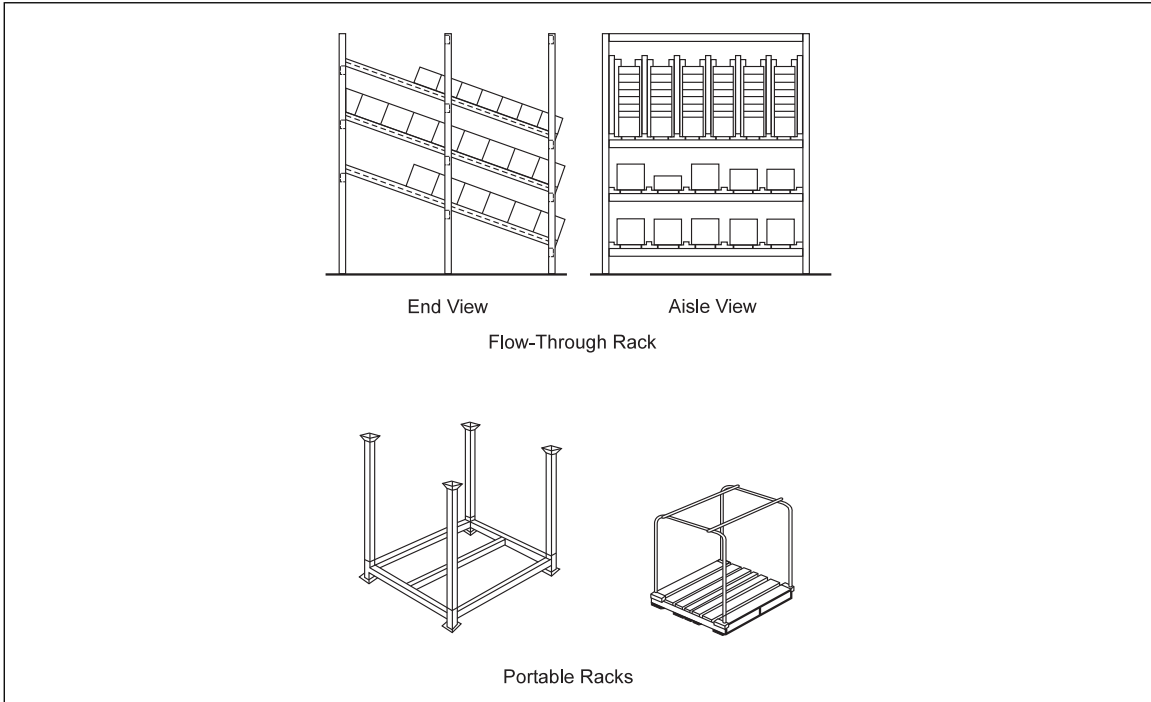

Fig. A-10. Flow-through and portable racks

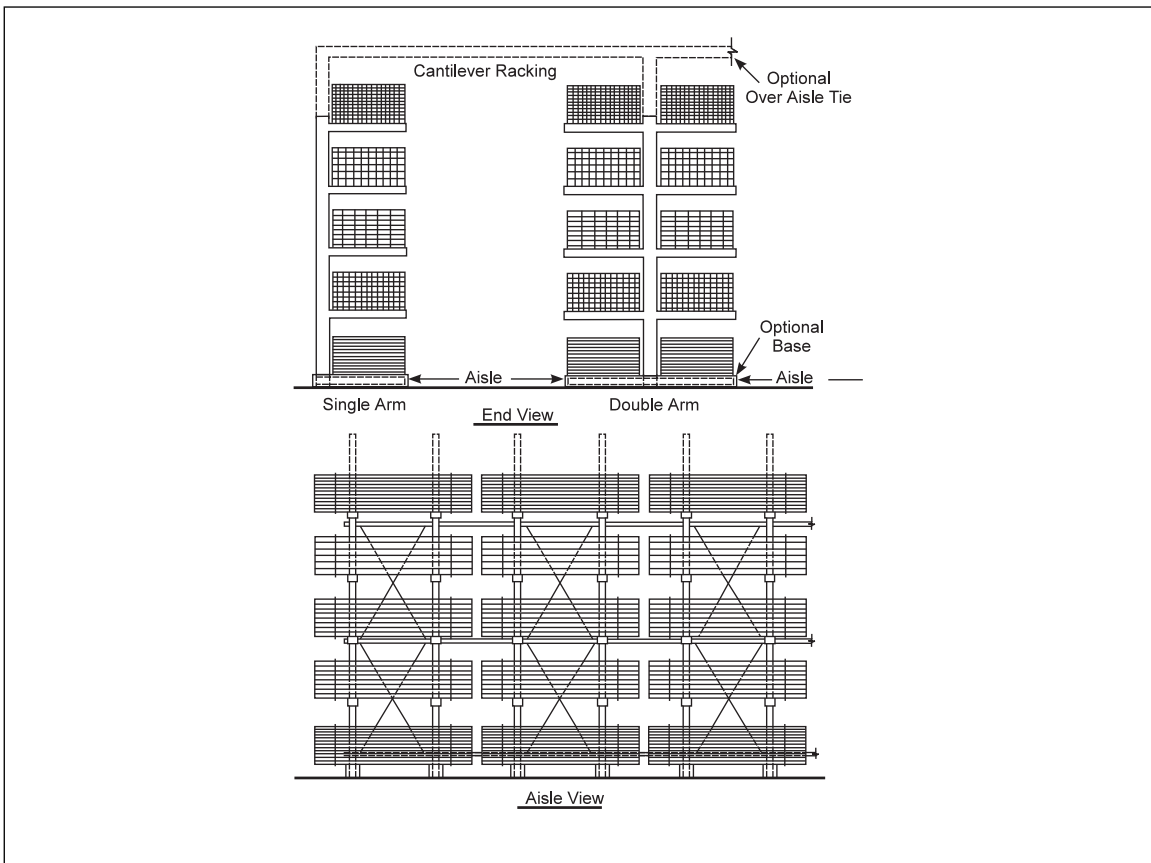

Fig. A-11. Cantilever rack

Storage Height: The measurement from the floor to the top of storage. If the storage on the bottom tier is maintained on a horizontal support member, then the storage height can be measured from the underside of the storage on the bottom tier level to the top of storage.

Tier: Each vertical segment of storage within a rack.

Water Delivery Time: The time interval, measured in seconds, that is defined by the following two events:

- (1) The point in time when the most hydraulically remote sprinkler, or sprinklers, is opened on a dry-pipe, preaction, or similar type of sprinkler system equipped with an automatic opening system valve.
- (2) The point in time when the water pressure at the most remote sprinkler, or sprinklers, reaches and doesn't drop below the required design pressure for the sprinkler system.

See Figure A-12 for an example arrangement of an inspector's test connection using 2 sprinklers on the most remote branchline, or Figure A-13 for an example of an inspector's test connection using 4 sprinklers, 2 sprinklers on the most remote 2 branchlines.

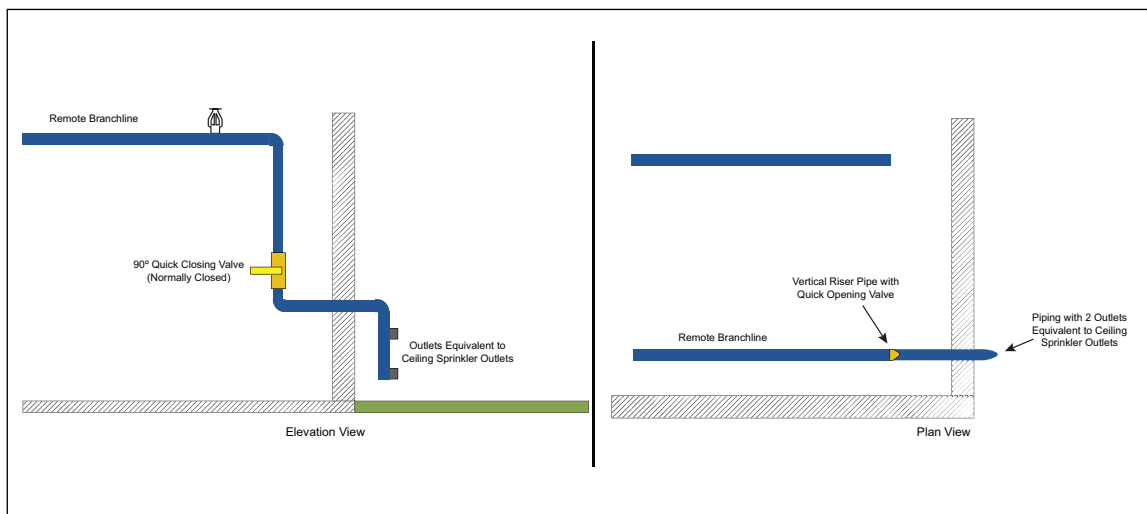

Fig. A-12. Example arrangement of an inspector's test connection for a dry sprinkler system design using 2 sprinklers on the most remote branchline

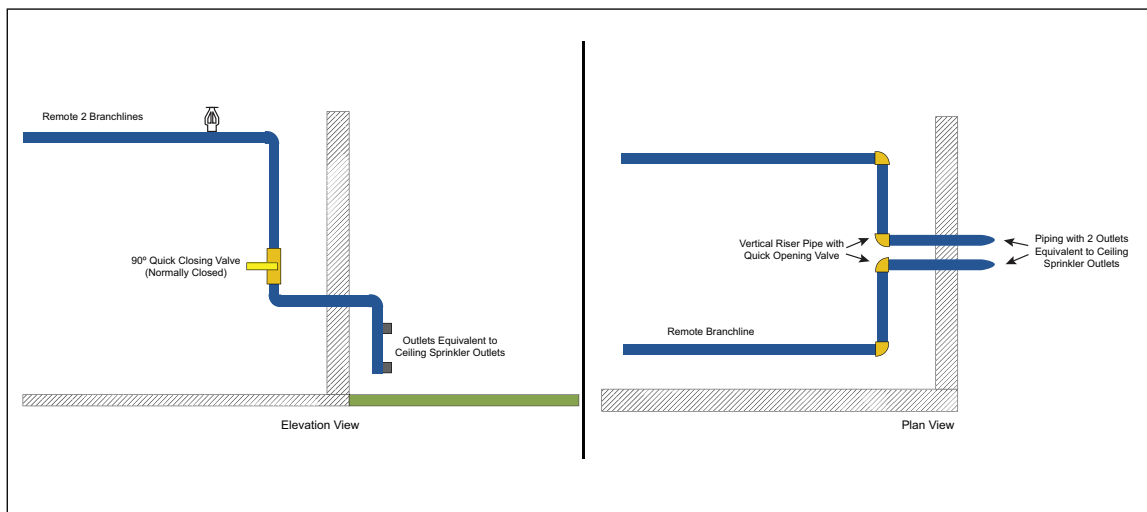

Fig. A-13. Example arrangement of an inspector's test connection for a dry sprinkler system design using 2 sprinklers on the most remote 2 branchlines (4 sprinklers total)

APPENDIX B DOCUMENT REVISION HISTORY

The purpose of this appendix is to capture the changes that were made to this document each time it was published. Please note that section numbers refer specifically to those in the version published on the date shown (i.e., the section numbers are not always the same from version to version).

October 2024. Interim revision. Minor editorial changes were made.

January 2022. Interim revision. The size of the longitudinal flue space in Section 2.2.3 is being changed from 6 in. (150 mm) to a net width of 3 in. (75 mm) so that it matches the guidance indicated in the October 2020 Edition of Data Sheet 8-9.

July 2021. Interim revision. Significant changes include the following:

- A. Updated the scope to reflect recent changes to Data Sheet 3-26, *Fire Protection for Nonstorage Occupancies*.
- B. Section 2.2.3:
 - Changed title to “Storage Arrangements.”
 - Moved the guidelines for portable and moveable racks to this section.
 - Moved the requirements for each storage arrangement to this section.
 - Added figures to help visually demonstrate the flue space guidelines for open-frame racks.
- C. Section 2.2.4:
 - Changed title to “Open-Top Containers.”
 - Added guidance on eliminating and protecting the open-top container hazard.
 - Added in-rack sprinkler protection guidelines for open-top containers based on testing conducted for Data Sheet 8-34, *Protection of Automatic Storage and Retrieval Systems*.
- D. Clarified how many sprinklers are needed per branchline in the hydraulic calculation for the ceiling-level sprinkler design (Section 2.3.3.7.2.6).
- E. Added new guidelines to indicate when water shields are needed for in-rack sprinklers.
- F. Updated Section 2.3.4.3.2 to recommend that all in-rack sprinklers be quick-response.
- G. Added new guidance for protecting in-rack sprinklers from damage during material handling operations.
- H. Added recommendation for face sprinklers when proper in-rack sprinkler clearance is not available (Section 2.3.4.6).
- I. Added protection guidelines for uncartoned unexpanded plastics (Section 2.3.6.5).
- J. Added Figure 5a to address the horizontal in-rack sprinkler arrangements for single-row racks deeper than 3 ft (0.9 m).
- K. Added Figure 6a to address the horizontal in-rack sprinkler arrangements for double-row racks deeper than 9 ft (2.7 m).
- L. Removed the designs for a maximum ceiling height of 35 ft (10.5 m) from Tables 14a and 14b.
- M. Modified Table 15 so only uncartoned expanded plastic commodities require in-rack sprinklers in adjacent storage racks to be included in the in-rack sprinkler system design.
- N. Moved all requirements in Appendix A to the guidelines of the data sheet. In addition, the definition for single-row and double-row racks were modified to indicate they are defined by minimum 4 ft (1.2 m) wide aisles as opposed to 2 ft (0.6 m) aisles.

October 2020. Interim revision. Significant changes to this edition of the data sheet include the following:

- A. Clarification was provided in Section 2.2.3.1.3 as to when longitudinal flue spaces are not required within double-row racks
- B. The aisle width that defines the depth of a multiple-row rack not provided with longitudinal flue spaces was added to Section 2.2.3.1.5
- C. Guidance regarding the maximum stored product overhang beyond a horizontal barrier was added to Sections 2.3.4.6.3 and 2.3.6.4 to be consistent with the guidance provided in Section 2.3.6.7.1(D)

D. Tables 14a, 14b and 17b were updated to allow open-frame multiple-row racks, as defined in Sections 2.2.3.1.4 and 2.2.3.1.5, to be protected in accordance with their design options

E. The ceiling sprinkler protection options offered in Section 2.3.6.5 for both quick-response K14.0 (K200) and K16.8 (K240) pendent sprinklers were clarified when they are being used to protect the storage of uncartoned unexpanded plastics

F. The definition of open-frame multiple-row racks was updated in Appendix A to match the requirements indicated in Sections 2.2.3.1.4 and 2.2.3.1.5

July 2020. Interim revision. Significant changes include the following:

A. Updated protection Tables 2 through 11.

B. Updated Table 13 to reflect the modifications made in protection Tables 7 through 11. In addition, the table was modified to include both the appropriate ceiling height for design purposes for the ceiling-level sprinklers in the presence of in-rack sprinklers, with a new column indicating which protection table to use.

C. Modified Section 2.2.5.1.3 regarding in-rack sprinkler protection arrangements for open-top containers.

D. Updated Section 2.2.3 to clarify recommendations for flue spaces.

E. Added guidance in Sections 2.3.4.9 and 2.3.6.5 to clarify that the in-rack sprinkler systems for these protection options are intended to be on a wet-pipe sprinkler system.

F. Modified Section 2.3.6.9 to address ceiling heights over 40 ft (12 m) (was 45 ft [13.5 m]).

G. Updated Section 2.3.6.9 to include protection for on-floor storage of uncartoned unexpanded plastics up to a maximum storage height of 25 ft (7.5 m) under a maximum ceiling height of 45 ft (13.5 m).

January 2020. Interim revision. Data Sheet 8-9 was modified as follows:

A. Table 1 was updated to include sprinkler spacing guidelines for quick-response, K28.0 (K400) pendent storage sprinklers.

B. The information previously provided in Sections 2.3.6.9.1 and 2.3.6.9.2 has been combined and is now provided in Section 2.3.6.9.

C. Table 17b was modified based on recent testing with quick-response K28.0 (K400) and K33.6 (K480) pendent storage sprinklers. In addition, the sprinkler designs within Table 17b were updated.

October 2019. Interim revision. Minor editorial changes were made.

July 2019. Interim revision. A new Section 2.3.6.9 has been created to address the installation and design guidelines for ceiling-only protection options involving ceiling heights of 50 ft (15 m) and 55 ft (16.5 m).

July 2018. Interim revision. A new Section 2.3.6.8 has been created to address the installation and design guidelines for protection scheme using quick-response K25.2EC (K360EC) pendent sprinklers as in-rack sprinklers in combination with horizontal barriers to protect open-frame rack storage of commodity hazards up to and including cartoned unexpanded plastics when the in-rack sprinkler protection was installed 30 ft (9.0 m) above floor level.

January 2018. Interim revision. The following changes were made:

A. Section 2.2.5.1 regarding open-top containers was revised to (1) remove the option where containers could be mixed within storage if they did not extend into the transverse flue spaces, (2) remove the option of placing a flat or domed-shaped fixed-in-place lid over the top tier of storage, and (3) clarify the in-rack sprinkler arrangement needed in the presence of open-top combustible containers. Due to these changes, Section 2.3.4.6.3.1 was also modified.

B. Section 2.3.6.1 was modified to incorporate all of the ceiling-only protection design guidelines for Class 1, 2 and 3 commodities under ceilings that are over 30 ft (9.0 m) protected by dry-pipe and similar sprinkler systems. Both Tables 2 and 7 were modified as part of this revision.

C. Protection guidelines for the newly FM Approved standard-response, standard-coverage, 280°F (140°C) nominally rated K33.6 (K480) upright sprinkler were incorporated into Section 2.3.6.1.

D. Figures 10 through 14 were modified to clarify where in-rack sprinklers are needed horizontally within a storage rack structure.

E. The footnotes in Tables 4, 6, 9, and 11 regarding the Tyco TY9226 sprinkler have been removed.

F. The guidelines in Table 6 for the quick-response, upright K14.0 (K200) and K16.8 (K240) sprinklers were revised.

June 2015. Interim revision. The following changes were made:

- Added a new section (2.3.6.6) on in-rack sprinkler protection based on recent testing
- Added a new section (2.3.6.7) on a potential in-rack sprinkler retrofit protection option for uncartoned unexpanded plastics stored in open-frame double-row racks
- Incorporated Engineering Bulletins 06-11 and 07-12
- Modified the designs for K11.2 (K160) and standard-response K16.8 (K240) upright sprinklers so the pressure values represent the values that were tested
- Modified Tables 2, 3, 7 and 8 based on recent testing of the quick-response K22.4 (K320) pendent sprinkler
- Modified the dry system designs in Table 5 so they are consistent with Table 10
- Modified the protection options in Tables 5, 6, 10 and 11 for both the quick-response K22.4 (K320) pendent and quick-response K25.2 (K360) pendent sprinklers based on recent testing
- Modified the hose and duration requirements for Scheme 8-9A
- Clarified guidance in Sections 2.3.2.5, 2.3.3.7.2.3 and 2.3.3.7.3.1

January 2011. Clarifications were made in Section 2.3.3.7.2, *Ceiling-Level Design Guidelines*.

September 2010. This data sheet has been revised to incorporate the following changes:

- The footnote regarding the Tyco TY9226 sprinkler was inadvertently left out of the March 2010 version of Data Sheet 8-9. It has been added back into this data sheet and is found at the bottom of Tables 4, 6, 9 and 11.
- Table 1 was modified to show a reduced linear and area spacing for K25.2EC (K360EC) sprinklers when the ceiling height exceeds 30 ft (9.0 m) and the protection is based on ceiling-only designs
- The ceiling-level design for the K25.2EC (K360EC) pendent quick-response sprinkler for ceiling heights up to 35 ft (10.5 m) was modified in Tables 2, 3, 7 and 8 from 6 sprinklers to 8 sprinklers.
- The ceiling-level design for the K25.2 (K360) pendent standard-response sprinkler for ceiling heights of 25 ft (7.5 m) and 30 ft (9.0 m) was modified in Table 8 from a pressure of 15 psi (1.0 bar) to 10 psi (0.7 bar).
- The ceiling-level designs for the K25.2EC (K360EC) pendent and upright quick-response sprinkler for ceiling heights up to 25 ft (7.5 m) were modified in Tables 2, 3, 4, 7, 8 and 9. In addition the ceiling-level design for this sprinkler was also changed in Table 4 for a ceiling height of 30 ft (9.0 m).

March 2010. This data sheet has been revised to incorporate the following changes:

A. The protection tables have been reorganized into five categories based on the following commodities:

1. Class 1, Class 2, and Class 3 commodities
2. Class 4 and Cartoned Unexpanded Plastic commodities
3. Cartoned Expanded Plastic commodities
4. Uncartoned Unexpanded Plastic commodities
5. Uncartoned Expanded Plastic commodities

B. The terms “Control Mode Density Area (CMDA) sprinkler,” “Control Mode Specific Application (CMSA) sprinkler,” and “Suppression Mode sprinkler” have been replaced with the term “Storage sprinkler.” This new terminology allows for the following changes:

- Only sprinklers considered acceptable for the protection of the commodities addressed in this data sheet, either at ceiling level or within storage racks, are listed as protection options.
- All ceiling-level sprinkler protection options for a given commodity and storage arrangement are listed in a single protection table.

- All ceiling-level sprinkler protection options are based on a single design format (i.e., number of sprinklers @ minimum operating pressure).

C. The following parameters are no longer considered when determining protection options:

- Storage height
- Aisle width
- Favorable and Non-Favorable factors

D. Section 2.2.5.1 on open-top combustible containers has been modified and now also addresses when open-top noncombustible containers need special consideration.

E. The maximum recommended flow for a K5.6 (K80) in-rack sprinkler has been increased to 30 gpm (115 L/min).

June 2009. Minor editorial changes were made for this revision.

January 2009. Corrections were made to Table 2.3.7.5(b). Also, corrections were made to the metric demand areas in Table 2.3.7.3(l), CMDA Sprinklers Installed on Dry System for Rack Storage up to 25 ft (7.5 m) of Uncartoned Expanded Plastic Commodities.

May 2008. Figure 2.3.4.2(d) was modified due to an editorial error.

January 2008. Combined the protection guidelines for Class 1 and 2 commodities protected by CMDA sprinklers into a single protection table.

Subdivided the protection tables for CMDA and CMSA sprinklers into those providing recommendations for wet-pipe sprinkler systems and those for dry-pipe sprinkler systems. As a result, it is no longer necessary to make an adjustment due to the presence of a dry-pipe sprinkler system.

Eliminated the need to interpolate for density and/or demand area within the CMDA protection tables.

Eliminated the need to adjust density and/or demand area values obtained from the CMDA sprinkler protection tables due to the presence of (1) dry-pipe sprinkler systems, (2) 160°F (70°C) temperature rated sprinklers, or (3) encapsulation.

Added a recommendation to use a nominal temperature rating of 160°F (70°C) for all ceiling-level sprinklers in wet-pipe sprinkler systems, and a nominal temperature rating of 280°F (140°C) for all ceiling-level sprinklers in dry-pipe sprinkler systems.

Added recommendation to base ceiling-level CMDA sprinklers on a minimum K-factor value of 11.2 (160). As a result, the minimum ceiling level density in all protection tables is 0.30 gpm/ft² (12 mm/min), based on a minimum sprinkler pressure of 7 psi (0.5 bar) and a maximum sprinkler area spacing of 100 ft² (9.0 m²).

Standardized the density values in the CMDA sprinkler protection tables to end in zero or five.

Created new terms for the various configurations of in-rack CMDA and CMSA sprinklers protecting rack storage up to 25 ft (7.5 m) high. They are defined as follows:

| <i>Old Term</i> | <i>New Term</i> | <i>Meaning of New Term</i> |
|--------------------------|-----------------|--|
| 1 level IRAS | IRAS(EO) | One level of in-rack sprinklers spaced horizontally at every other transverse flue space |
| 2 levels IRAS | IRAS(E) | One level of in-rack sprinklers spaced horizontally at every transverse flue space |
| 3 or 4 levels IRAS | 2 IRAS(E) | Two levels of in-rack sprinklers spaced horizontally at every transverse flue space |
| IRAS at every tier level | IRAS(ETL) | One level of in-rack sprinklers at every tier level spaced horizontally at every other transverse flue space |

Provided new protection options in some CMDA sprinkler protection tables to either (1) increase density values (which lowers the size of the demand area), or (2) increase in-rack sprinkler arrangement values (which lowers the ceiling density value required).

As a result of recent testing, removed the recommendation allowing CMDA and CMSA sprinklers to be used at ceiling-only protection for rack storage of Class 4 and cartoned plastic commodities in buildings over 30 ft (9.0 m) high.

Removed the recommendation for steel column protection from CMDA sprinkler protection tables.

Added recommendation that in-rack sprinklers be quick-response type with a minimum K-factor value of 5.6 (80) for in-rack sprinkler flows less than 30 gpm (115 L/min) or K8.0 (K115) for in-rack sprinklers where the required flow is 30 gpm (115 L/min) or higher.

Added recommendation to provide longitudinal and face in-rack sprinklers for double-row racks over 9 ft (2.7 m) wide and up to 12 ft (3.6 m) wide.

Modified most of the figures representing the location of in-rack sprinklers. With the exception of Figure 2.3.7.3(h), they no longer show in-rack sprinkler arrangements incorporating vertical and/or horizontal stagger.

Removed uncartoned unexpanded plastic commodities from the in-rack protection schedule shown in Figure 2.3.7.3(g).

Added figures representing the location of both single-row and double-row in-rack sprinklers for storage racks up to 25 ft (7.5 m) high.

Changed the term "Scheme A" to "Scheme 8-9A" in order to avoid confusion with the in-rack protection layout called "Scheme A" in Data Sheet 7-29, *Flammable Liquid Storage in Portable Containers*.

Replaced the protection options previously provided in the suppression mode sprinkler protection tables for 32 ft (9.6 m) high ceilings with protection options based on 35 ft (10.5 m) high ceilings.

Added recommendation that the maximum width of a flue space be 24 in. (0.6 m). As a result, the definition of an aisle has been revised to be a horizontal distance between two storage racks that is wider than 2 ft (0.6 m).

Enhanced the definition of bin-box storage.

Enhanced the definition of portable racks to indicate a portable rack with a solid bottom and three solid fixed-in-place noncombustible or wooden sides that will inhibit horizontal fire spread can be treated as a solid-piled storage arrangement with favorable factors.

Changed the definition of "tier" to refer to any vertical storage segment.

May 2006. Minor editorial changes were made for this revision.

January 2006. Revisions were made to Table 2.3.7.3(r).

September 2005. Revisions were made to the different tables.

May 2005. Revisions were made to the Table 2.1.2(a).

January 2005. Minor editorial changes were made for this revision.

Changes made in the September 2004 revision include:

Terminology for Sprinklers: FM Approvals now uses four separate categories of sprinkler type, three of which are now utilized in this version. They are Suppression Mode (formerly referred to as ESFR), Control Mode Specific Application (formerly referred to as Large-Drop) and Control Mode Density Area (formerly referred to as Standard) sprinklers.

Due to the number of new sprinkler types now available for use, the protection tables have been reformatted based on sprinkler type, as well as commodity hazard and storage arrangement. The reformatting of the protection tables lead to a reorganization of the data sheet with subsections now based on sprinkler type rather than storage arrangement.

Protection options for Plastic commodities no longer take into account Group type, but simply whether they are unexpanded or expanded, and whether they are cartoned or uncartoned. In addition, reference to polyurethane plastic and rubber have also been removed from the data sheet as Data Sheet 8-1, Commodity Classification, addresses how to classify the hazard they present.

The protection options for Shelf storage are now grouped with Bin-Box storage rather than Solid-Piled and Palletized storage. In addition, Shelf storage and Bin-Box storage are considered to have inherently Favorable

Factors, regardless of the type of Plastic commodity. As a result, Favorable Factors has to be determined as "Yes" or "No" only for Plastic commodities maintained in either a Solid-Piled or Palletized storage arrangement and protected by Control Mode Density Area sprinklers.

The protection tables for Control Mode Density Area sprinklers protecting rack storage over 25 ft (7.5 m) high have been modified in several ways. There are now nine protection tables instead of two, with each table specific to the rack type (SRR, DRR or MRR) and the size of the shelving present (open, 20-64 ft², or greater than 64 ft²). As a result, Table 3.3.7.3(AA), 20 to 64 ft² (1.9 to 5.9 m²) Solid Shelves, has been eliminated. Other modifications to the protection tables include (1) the tables no longer include columns for IRAS Face and Longitudinal Flue Spacing or IRAS Stagger, (2) instead of a Note that indicates possible adjustments to the table's indicated density, the tables now provide the density and demand area for storage heights either (a) up to 5 ft (1.5 m) above the top level of in-rack sprinklers or (b) over 5 ft (1.5 m) and up to 10 ft (3.0 m) above the top level of in-rack sprinklers, (3) for a given height of storage above the top level of in-rack sprinklers, the density requirements for all three storage arrangements are now the same.

The figures representing in-rack sprinkler spacing and location for rack storage over 25 ft (7.5 m) high protected by Control Mode Density Area sprinklers have been modified as follows, (1) each figure is specific to both the rack type and the shelving size, (2) the in-rack sprinklers shown in each figure's Plan View are now represented at the intersection of the transverse flue spaces, and (3) information regarding the in-rack sprinkler's spacing and location is now provided as a Note on the figure.

Reference for earthquake protection of both storage racks and sprinkler systems has been added to the data sheet.

Comparisons to other standards, such as NFPA, have been deleted. As a result, Section 5.4, National Fire Protection Association (NFPA) Standards, has been eliminated.

Metric values provided in this version of the data sheet have been modified, as needed, so they are now based on "realistic" and "design desired" values instead of strict mathematical conversion values.

New protection options have been provided within the protection tables for all storage arrangements involving Control Mode Specific Application sprinklers to account for excessive clearance. In addition, new protection options have been provided within the protection tables for solid-piled, palletized, shelf and bin-box storage arrangements protected by Control Mode Density Area sprinklers to account for excessive clearance.

In an effort to simplify the options available to the user, new supporting tables have been created for the hazard associated with Open-Top Combustible Containers (all sprinkler types) and Excessive Clearance (Control Mode Density Area). In addition, two new options have been added to the new Excessive Clearance table to help account for excessive clearance involving Control Mode Density Area sprinklers.

A new supporting table has been created that provides the required density and demand area for ceiling-level Control Mode Density Area sprinklers when extra levels of in-rack sprinklers are provided. This table replaces the previous Table 3.3.7.2(AA), Ceiling Sprinkler Density Adjustments, which provided guidelines on how to adjust the density obtained from a protection table. As a result, an adjustment to the existing density obtained from the protection tables is no longer necessary due to the presence of extra levels of in-rack sprinklers.

The wording previously listed in Section 3.3.4, In-Rack Sprinklers (IRAS), has been amended to stress the critical importance of locating the in-rack sprinklers at the intersection of flue spaces as well as providing a proper stagger for multiple in-rack sprinkler levels in the absence of horizontal barriers.

The protection option known as "Scheme A" from Data Sheet 7-29 has been incorporated into this version of the data sheet as a means of isolating and protecting small amounts of high hazard commodities that cannot be protected by the existing or proposed sprinkler systems. The design provided in Data Sheet 7-29 has been modified for this data sheet as follows: (1) the number of in-rack sprinklers flowing is based on 6 sprinklers if the rack to be protected with Scheme A protection is single-row, or 8 sprinklers if the protected rack is double- or multiple-row; (2) the number of in-rack sprinklers in the design is not tied to a number of sprinklers flowing on 2 lines; (3) the design is based on a minimum flow of 60 gpm (230 L/min) instead of 50 psi (3.5 bar); and (4) the use of FM Approved K11.2 (K160) quick-response sprinklers are permitted in addition to FM Approved K8.0 (K115) quick-response sprinklers.

The minimum operating pressure for all Control Mode Density Area sprinklers is now 7 psi (0.5 bar).

The horizontal and vertical spacing for in-rack sprinklers is now consistent throughout the data sheet regardless of storage height or aisle width.

The previous Section 3.3.7.2.3, Special Procedure for Evaluating Existing Systems Using Standard or ELO Sprinklers to Protect Class 1-4 Commodities and Which Have Ceiling Sprinkler Design Areas Other than 2000 ft² (186 m²) for Wet Pipe Systems, or 2,600 ft² (242 m²) for Dry-Pipe Systems (and Preaction Systems Treated as Dry-Pipe Systems), has been eliminated.

Table 3.3.7.4(AA), Suppression Mode (ESFR) Automatic Sprinkler Protection for Plastic Commodities, has been eliminated since the information it contained has been incorporated into the new protection tables.

Table 3.3.3.2, Extension Design Area for 286°F (141°C) Sprinklers, has been eliminated. The data sheet now recommends that the extension of the design and the sprinkler type protecting the area with the higher hazard be the same.

Tables 3.3.7.2, Rack Storage Up Through 25 ft (7.6 m) High, and 3.3.7.4, Solid-Piled, Palletized, Shelf and Bin-Box Storage, have been eliminated due to the reorganization of the data sheet.

Any information that is not specific to this data sheet and is covered in other FM data sheets has been eliminated. As a result, information previously provided in Sections 3.1.2, Roof Construction, 3.1.3, Roof Slope, 3.3.4.6, In-Rack Sprinkler Piping, 3.3.4.7, In-Rack Sprinkler Control Valves, 3.3.4.8, In-Rack Sprinkler System Size, 3.3.4.9, In-Rack Sprinkler System Waterflow Alarms and Test Connections, and Figure 3.3.4.7, Supply pipe arrangement to sprinklers at ceiling and in-racks, have been eliminated. In addition, the location requirements of heat detection for pre-action in-rack sprinkler systems has also been eliminated and replaced by the appropriate reference in other data sheets.

As a supplement to the two existing figures representing in-rack sprinkler protection for multiple-row rack storage up to 25 ft (7.5 m) high, two new figures were added. They include (1) a second option of in-rack sprinklers when the protection tables indicate that more than one level of in-rack sprinklers is required, and (2) a representation of the in-rack sprinkler arrangement when solid shelves greater than 64 ft² (6.0 m²) are present. In addition, Figure 2.3.4.2(b) has been modified so that all the "X" in-rack sprinklers are at the top of the second tier level and all of the "triangle" in-rack sprinklers are at the top of the fourth tier level, in order to reduce the cost of the installation to a FM client while at the same time offering the same level of in-rack sprinkler protection.

Former Figure 3.3.7.3(k), which is now Figure 2.3.7.3(l), has been clarified that it applies only to wet-pipe sprinkler systems.

Section 2.1.1, General, has been enhanced to include a recommendation for proper anchorage of the storage racks.

Table 2.1.3.1, Acceptable Types of Heat and Smoke Vents, has been modified to account for a new FM Approved drop-out heat vent that is acceptable in the presence of Suppression Mode sprinklers. In addition, the recommendation to provide an additional sprinkler under the center of a vent that cannot be equipped with a temperature link per Table 2.1.3.1 has been amended to say that the additional sprinkler should be quick-response.

The definition of "Flue Spaces" in Section 2.2.2 and Appendix A has been enhanced to include the minimum clear space needed in order to be considered acceptable for rack storage shelving purposes.

The requirement of longitudinal flue spaces for double-row racks over 25 ft (7.5 m) high has been eliminated from Section 3.2.2, Flue Spaces, Pile Stability, Product Spillage and Product Form. However, this is only permissible as long as there are no longitudinal flue spaces for the entire vertical height of the rack.

Portable racks were added to former Section 3.2.4 (now Section 2.2.4), Special Storage Considerations, and provided with additional guidance to define when they can be treated and protected as open-frame (multiple-row) racks.

The term "Single-Row Rack" was eliminated from any reference for racks wider than 9 ft (2.7 m) in Section 3.3.4.2.1, Open-Frame Racks with No Solid Shelves, since a single-row rack cannot be this wide.

Additional information has been provided in Section 2.3.7.3.4, Favorable vs. No Favorable Factors, to help better clarify the term Favorable Factors.

Section 2.0, General, has been deleted and the definition of terms has been relocated to Appendix A.

The section on Interpolation for Control Mode Density Area sprinklers has been modified to include an equation for interpolation.

The definition for "Aisle" in Appendix A has been enhanced to include the minimum acceptable width of 4 ft (1.2 m) so that it is consistent throughout the data sheet.

The definition for "Clearance" in Appendix A has been enhanced to include and define the term "excessive clearance".

The definition of "Rack Storage" in Appendix A has been modified so that a minimum distance of 4 ft (1.2 m) is now required to avoid single-row or double-row racks as being treated as multiple-row racks, the definition for portable racks has been enhanced to stress the need for acceptable flue spaces in order to be treated as open-frame (multiple-row) racks, grating must be a minimum of 70% to be considered open-frame, and slatted shelves that are not fixed-in-place automatically default to solid shelves.

The definition of "Rack Storage Sprinklers" in Appendix A has been enhanced to stress the importance of locating the sprinklers at the intersection of flue spaces and providing, when required, vertical stagger.

The definition of "Solid Shelving" in Appendix A has been enhanced to stress the need for openings at the transverse flue spaces in order to be considered open-frame racks.

Efforts were made to eliminate as many notes as possible from the protection tables.

May 2003. Minor editorial changes were made.

January 2003. Recommendation 3.3.3.5 Storage Clearance added.

September 2002. The following new sections have been added:

Section 3.3.8.5 was added to incorporate the guidelines for the K22.4 suppression mode sprinkler previously covered in Engineering Bulletin #06-01.

Section 3.3.8.6 was added to incorporate the guidelines for the newly Approved TYCO Model TY7126 K16.8 Upright Suppression Mode Sprinkler.

September 2001. In line with the changes described in Section 1.2, item 1, under "Changes made in the May 2001 Revision," the following changes are incorporated into the September 2001 version:

1. In Tables 3.3.7.2(a), (d), (g), and (j), in the ESFR column for all four storage heights and building height of 45 ft (13.5 m), replaced "12 @ 90 psi (6.1 bar)" with "DNA."
2. In Table 3.3.7.2(m), in the ESFR column for all four storage heights and building height of 45 ft (13.5 m), replaced "Note 13" with "DNA," and also deleted Note 13 that follows that table.

Note: "12 @ 90 psi (6.1 bar)" entries in Table 3.3.7.4(a) through (d) for solid-piled/palletized storage to 35 ft (10.5 m) in 45 ft (13.5 m) buildings remain valid as the change made in the May 2001 version applied only to rack storage.

May 2001. The following changes were made:

1. The guidelines in Section 3.3.7.3, item 1, part b for protecting storage of Class 1-4, and cartoned and uncartoned unexpanded plastic commodities in buildings over 40 ft (12.0 m) up to 45 ft (13.5 m) using K14.0 (K200) pendent suppression mode sprinklers at the ceiling only, have been rescinded as a result of recent testing. Item 1, part C has been renumbered as part b. Storage of Class 1-4 and cartoned unexpanded plastic commodities in 45 ft (13.5 m) high buildings can be protected by K25.2 (K360) suppression mode sprinklers at the ceiling only as outlined in Section 3.3.8.1. There is no longer a method for protecting uncartoned unexpanded plastic storage in buildings higher than 40 ft (12.0 m) with suppression mode sprinklers at the ceiling only.
2. A new Section 3.3.8.4 has been added to incorporate the guidelines for the K16.8 (K240) suppression mode sprinkler previously covered in Engineering Bulletin #15-00.
3. A new Section 3.3.8.5 has been added to incorporate guidelines for the upright K14.0 (K200) suppression mode sprinkler previously covered in Engineering Bulletin #14-00.

May 2000. The following changes were made:

1. New text is added in Section 2.2.2.1 to address flue spaces blocked by rolls of fabric, fiber or other materials and that create a solid shelf effect.
2. Tables 3.3.7.2(i), (l), (o) and (r) are revised to recommend in-rack sprinklers for racks up to 10 ft (3.0 m) high that have solid shelves greater than 64 ft² (6.0 m²) and are used to store Class 3, 4 and plastic commodities.
3. New guidelines are added in Section 3.3.8.1 for K25.2 (K360) suppression mode sprinklers to protect uncartoned unexpanded plastic storage.

September 1999. The following changes were made:

1. Guidelines for K-factor 25.2 (360) suppression mode sprinklers and for K-factor 16.8 (240) CMSA sprinklers has been relocated to new Section 3.3.8.
2. Engineering Bulletin 5-99, "K-factor 25.2 Suppression Mode Sprinklers for Exposed Expanded Polystyrene and Polyurethane in Closed Array Palletized or Solid-Piled Storage," dated June 7, 1999, has been incorporated in Section 3.3.8.

March 1997. The following changes were made:

1. Guidelines for use of suppression mode sprinklers in buildings up to 45 ft (13.5 m) high have been added. Note the limits on storage height and commodity, and required design pressures as covered in the appropriate tables and text. Commodity is limited to cartoned and uncartoned unexpanded plastic or less, and storage height is limited to 35 ft (10.5 m) for palletized / solid-piled storage and open-frame rack storage without in-rack sprinklers, and to 40 ft (12.0 m) open-frame rack storage when one level of quick-response in-rack sprinklers are installed per data sheet guidelines.
2. Figure 3.3.7.3(k) and the associated Table 3.3.7.3(a) reference have been changed to allow 9 ft (2.7 m) wide racks to accommodate common non-North American rack designs and pallet dimensions.